

CLASSIC

110 Dual Fuel

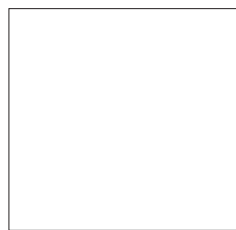

Users Guide

Installation & Service Instructions

U102060 - 09A



www.rangemaster.co.uk

Be safe

Warning

Accessible parts will become hot in use. To avoid burns and scalds children should be kept away.

You need clean fresh air - so does your cooker. Burner flames produce exhaust gases, heat and moisture. Make sure that the kitchen is well ventilated: keep natural ventilation holes open or install a powered cooker hood that vents outside. If you have several burners on or use the cooker for a long time, open a window or turn on an extractor fan. For more detail see the Installation Instructions.

We recommend you read the 'General Safety Instructions' section if you have not used a gas cooker before. We describe some basic guidelines on how to use a gas cooker safely.

Gas and Electricity on

Make sure that the gas supply is turned on and that the cooker is wired in and switched on.

The cooker needs electricity.

Peculiar smells

When you first use your cooker it may give off a slight odour. This should stop after a little use.

Before using for the first time, make sure that all packing materials have been removed and then to dispel manufacturing odours, turn the ovens to 200°C and run for an hour.

Make sure the room is well ventilated to the outside air, by opening windows or turning on a cooker hood for example. We recommend that people with respiratory or allergy problems should vacate the area for this brief period.

Before using the grill for the first time you should also turn on the grill and run for 30 minutes with the grill pan in position, pushed fully back, and the grill door open.

Installation

In the UK the cooker must be installed by a Gas Safe registered engineer. Failure to install the appliance correctly could invalidate any warranty or liability claims and lead to prosecution

This appliance shall be installed in accordance with the regulations in force and only in a well ventilated space. Read the instructions before installing or using this appliance.

This appliance should not be installed in a boat or caravan.

Contents

Hotplate burners	Page 4
The Griddle	Page 5
Warmer	Page 5
The Grill	Page 6
The Ovens	Page 7
The Clock	Page 8
Cooking using the timer	Page 9
Oven cooking	Page 10
Oven shelves	Page 10
The Handyrack	Page 11
Oven light	Page 11
The Browning Element	Page 11
Storage	Page 11
Oven cooking guide	Page 12
Cleaning your cooker	Page 14
Moving your cooker	Page 17
Troubleshooting	Page 18
General Safety Instructions	Page 20
Installation	Page 22
Servicing Notes	Page 30
Circuit Diagram	Page 34
Technical Data	Page 35

Hotplate burners

1

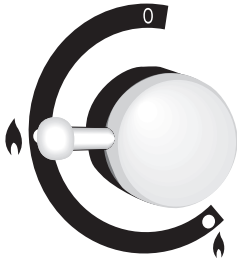

The drawing by each knob indicates which burner that knob controls.

Press the igniter button, and push in and turn a knob to the large flame symbol (🔥). Alternatively light with a match.

2

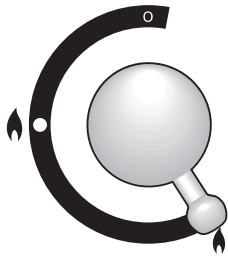

Adjust the flame height to suit by turning the knob. On this cooker the low position is beyond high, **not** between high and off. The small flame marks the 'low position'. Turn the knob towards it after the contents of a pan have boiled.

3

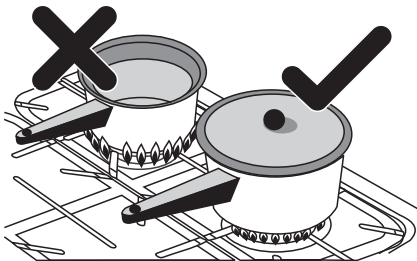

Make sure flames are under the pans. Using a lid will help the contents boil more quickly.

Pans and kettles with concave bases or down turned base rims should not be used.

4

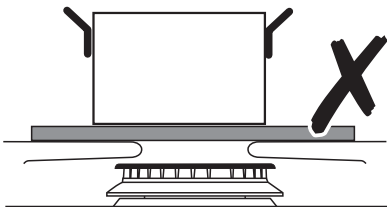

Simmering aids, such as asbestos or mesh mats, are **NOT** recommended. They will reduce burner performance and could damage the pan supports.

5

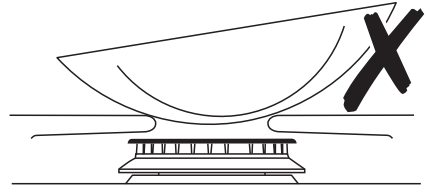

Avoid using unstable and misshapen pans that may tilt easily and pans with a very small base diameter e.g. milk pans, single egg poachers. The minimum pan diameter recommended is 120mm.

Pans and kettles with down turned base rims should not be used.

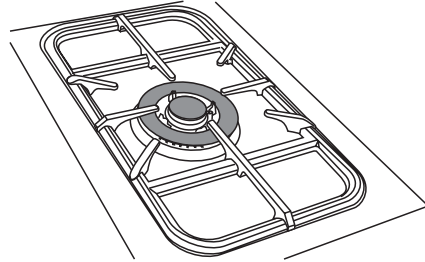

6

The Wok burner is designed to provide even heat over a large area. It is ideal for large pans and stir frying. For heating smaller pans the smaller burners may be more efficient.

If a burner flame goes out, turn the control knob off and leave it for one minute before relighting it.

You can remove the burner parts for cleaning, see the 'Cleaning your cooker' section of these instructions.

You should wipe the enamel top surface of the cooker around the hotplate burners as soon as possible after spills occur. Try to wipe them off while the enamel is still warm.

The Griddle

1

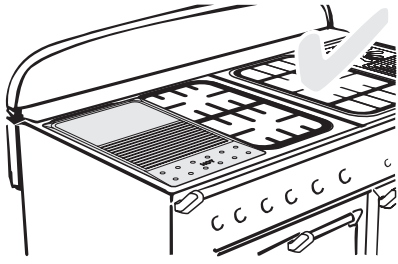

The griddle fits a single pan support, front to back. It is designed for cooking food on directly. Don't use pans of any kind on it. The griddle surface is non-stick and metal cooking utensils (e.g. spatulas) will damage the surface. Use heat resistant plastic or wooden utensils.

2

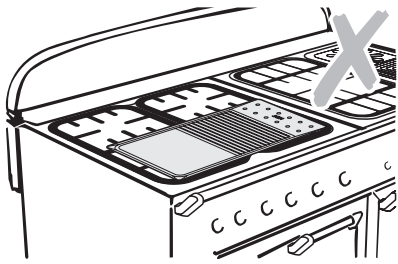

Don't put it crossways - it will not fit properly and will be unstable.

Don't put it on the Wok burner - it is not designed to fit the Wok burner pan support.

3

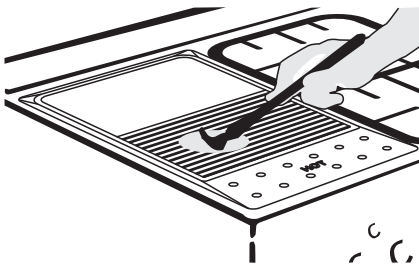

Position the griddle over the hotplate burners resting on the pan support. The griddle can be lightly brushed with cooking oil before use. Light the hotplate burners. Adjust the flame heights to suit.

4

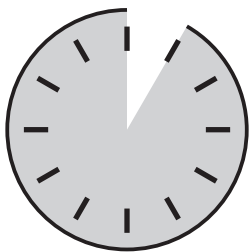

Preheat the griddle for a maximum of 5 minutes before adding food. Leaving it longer may cause damage. You can reduce the heat by turning the control knobs towards the lower position (marked with the small flame symbol).

5

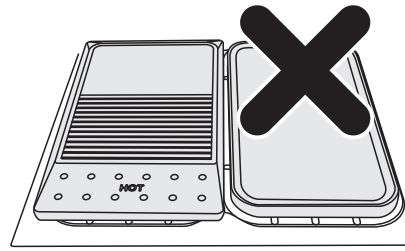

Always leave space around the griddle for the gases to escape. **Never** fit two griddles side by side. Large pans should also be spaced well apart. The maximum pan base diameter is 250mm.



Use the following heat settings as a guide for griddle cooking.

High/medium:

Drop scones, Bacon, Chops, Steak, Burgers.

Medium/low:

Potato cakes, Eggs, Fish cakes.

Experience will soon familiarise you with the correct setting to use for cooking.

After cooking allow the griddle to cool before cleaning.

If the griddle is washed in a dishwasher then some dishwasher residue may appear on the back. This is normal and will not affect the performance of your griddle.'

Warmer

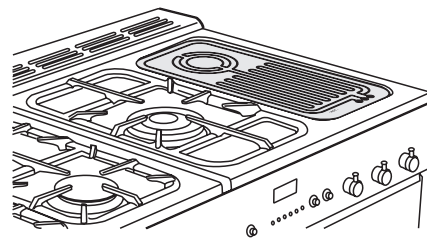

Use the warmer for keeping food warm while the final touches are put to a meal. Turn the control knob anti-clockwise to the on position. The 'HOT' indicator lights up. For best results, pre-heat a covered serving dish for 10 minutes before adding food to it.

CAUTION:- If a crack in the Warmer surface becomes visible, due to accidental damage etc., isolate the appliance from the electricity supply

immediately by turning it off at the wall and arrange for its repair.

DO NOT RECONNECT THE COOKER TO THE ELECTRICITY SUPPLY UNTIL AFTER REPAIR!

The Grill

CAUTION: Accessible parts may be hot when the grill is in use. Young children should be kept away.

Before using the grill for the first time turn on the grill and run for 30 minutes with the grill pan in position, pushed fully back, and the grill door open. Make sure the room is well ventilated to the outside air, by opening windows or turning on a cooker hood for example.

1

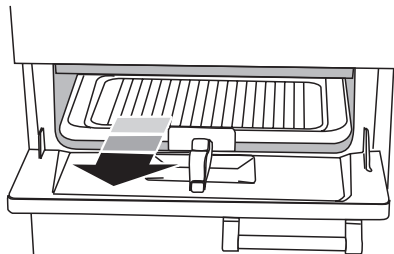

Remove the pan from the bottom of the grill compartment.

2

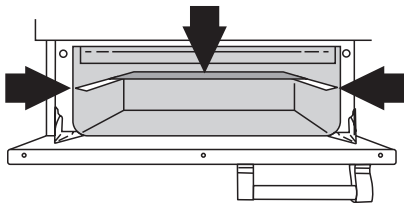

After placing your food on the grill tray pan, slide the grill pan onto the side supports just below the elements. Make sure it is pushed right in and touches the back stop.

3

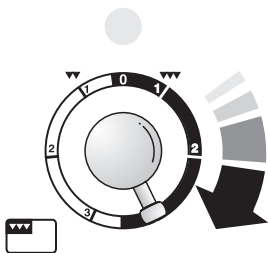

The grill has two elements that allow either the whole area of the pan to be heated or just the right hand half.

To heat the whole grill, turn the knob clockwise to position 3.

To heat the right hand half turn it anticlockwise.

4

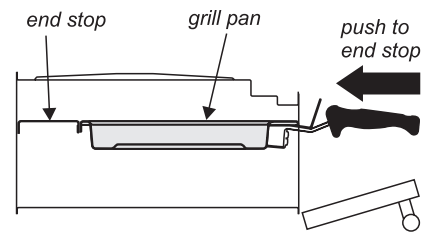

For best results preheat for 2 minutes with the grill pan in position. After placing your food on the grill pan grid, slide the grill pan onto the side supports. Adjust the heat to suit by turning the knob.

Make sure it is pushed right in and touches the back stop.

Never close the grill door when the grill is on.

5

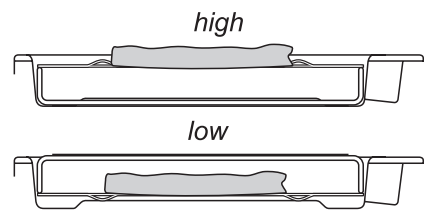

The grill pan grid can be turned over to give two grilling positions.



Don't leave the grill on for more than a few moments, without the grill pan underneath it.

For best results, especially with toast, preheat the grill with the grill pan in the cooking position for two minutes before use.

The grill trivet can be removed and the food placed on it while you are waiting for the grill to preheat.

The grill pan grid can be turned over to give two grilling positions.

You can brown the top of dishes cooked in the oven, under the grill by placing the dish onto the base of the grill pan, which can easily slide along the floor of the grill cavity.

The Ovens

During use the appliance becomes hot. Care should be taken to avoid touching the heating elements inside the ovens.

Before using for the first time, to dispel manufacturing odours turn the ovens to 200°C and run for an hour. To clear the smell make sure the room is well ventilated to the outside air, by opening windows or turning on a cooker hood for example. We recommend that people with respiratory or allergy problems should vacate the area for this brief period.

The clock must be set to the time of day before the ovens will work. See 'The Clock' section of these instructions for how to set the clock.

Before using for the first time, heat the ovens to 200°C for 30 minutes to dispel manufacturing odours. Open a window to clear the smell.

1

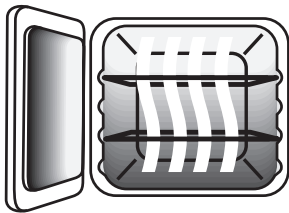

The Left hand Oven

The left hand conventional oven is fitted with two heating elements, one visible in the top of the oven and the second under the oven base.

Be careful to avoid touching the top element and element deflector when placing or removing items from the oven.

2

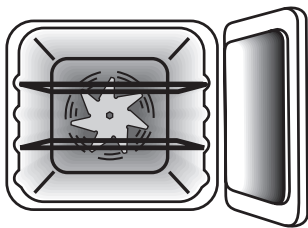

The Right hand Fan Oven

The fan in the right hand oven circulates hot air continuously, which means faster more even cooking.

The recommended cooking temperatures for a fanned oven are generally lower than a non-fanned oven.

3

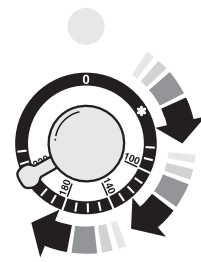

Turn the oven knob to the temperature you need.

4

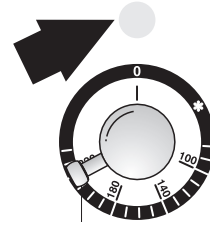

The oven indicator light will glow until the oven has reached the temperature you selected. It will then cycle on and off during cooking.

5

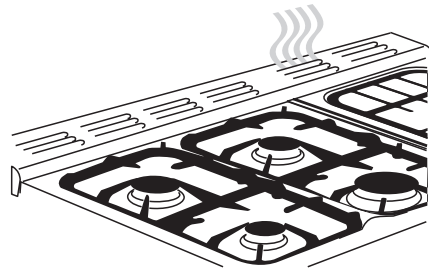

During cooking, food naturally produces steam, particularly when cooking foods with high water content (e.g. oven chips). There may be some steam visible at the grille at the rear of the hotplate and the bottom of the left hand door. This is perfectly normal. Steam can condense to water droplets on the cool outer trim or the oven door. It may be necessary during cooking to wipe away any moisture with a soft cloth. This will also help to prevent soiling and discolouration of the oven exterior by cooking vapours.

Take care when opening the oven door as there may be a momentary puff of steam when the oven door is opened. Stand well back and allow any steam to disperse.

The Clock

You can use the timer to turn the ovens on and off. The clock must be set to the time of day before the ovens will work.

To set the time of day

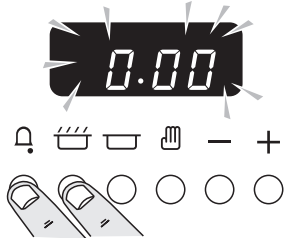

Press and hold as above. At the same time, press (-) or (+) until the correct time shows. Don't forget it's a 24 hour clock. If you make a mistake or press the wrong button, turn off the power supply for a minute or two and start again.

To time something that's cooking (minute minder)

Press and hold the Minute Minder (🔔).	
---------------------------------------	--

At the same time press (-) or (+) until the time you want to cook for is shown.	
---	--

You can check time remaining by pressing 🔔 and cancel the beeper by pressing 🔔.

To stop automatically

Use when you have started the oven manually.

Press and hold the Stop Time (📏) button.	
--	--

At the same time press (-) or (+) until your required 'Stop Time' shows. AUTO will show in the display. When your cooking is finished the beeper sounds. TURN THE OVEN KNOB TO 0 FIRST, then press 🔒 once to stop the beep,

press 🔒 again to return to manual cooking.

To start and stop the oven automatically

Before you set the clock, you must have two numbers clearly in mind.

The 'cook period', which is the period of time you want the oven to cook.

The 'stop time', which is the time of day you want the oven to stop cooking.

You cannot set a start time directly - this is set automatically by setting the cooking period and stop time.

Press and hold the Cook Time (🍲) button. At the same time press (-) or (+) until your required 'cook period' shows.	
---	--

Press and hold the Stop Time (📏) button. At the same time press (-) or (+) until your required 'stop time' shows. AUTO will show in the display.	
--	--

Set the oven to the required temperature. When your cooking is finished the beeper sounds. TURN THE OVEN KNOB TO 0 FIRST, then press 🔒 once to stop the beep, press 🔒 again to return to manual cooking.

If you are out, don't worry about the beeper going off, it stops after a while. When you return, TURN THE OVEN KNOB TO 0 FIRST, then press 🔒 twice, to return to manual cooking.

AUTO is showing, you want to reset to manual cooking.

When cancelling an automatic setting, any cooking time already set must be returned to 0.00 before you can return to manual, by pressing the 🔒 button.

Clock Special Features

Key Lock

When the key lock is activated, the clock can be operated as usual but the oven is locked and will not come on. This means that your child could

select a cook program but the program will not be activated and oven will not be switched on.

To activate the key lock

Make sure that the clock is in manual mode and cancel any active programs.

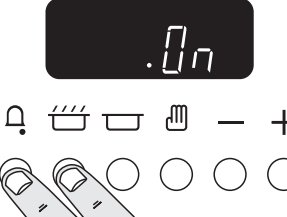
<p>Hold the Minute Minder (🔔) and Cooktime (🍲) buttons for about 8 seconds.</p> <p>'On' will appear on the display.</p>	
---	---

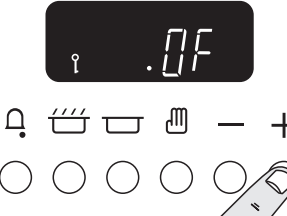
<p>Press the '+' button once.</p> <p>'Of' will appear on the display.</p>	
---	---

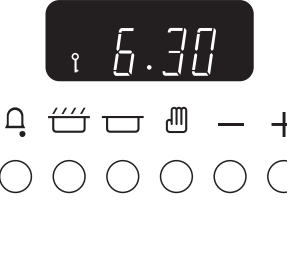
<p>The clock oven control functions are now locked.</p> <p>After a few seconds the display will revert to show the time of day and the key symbol (🔔).</p>	
--	--

To turn off the key lock

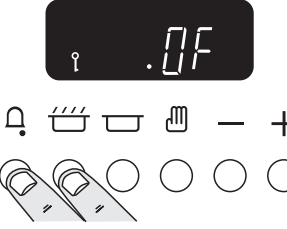
<p>Hold the Minute Minder (🔔) and Cooktime (🍲) buttons for about 8 seconds.</p> <p>'Of' will appear on the display.</p>	
---	---

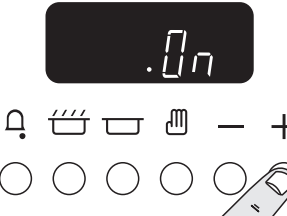
<p>Press the '+' button once. 'On' will appear on the display.</p>	
--	---

After a few seconds the display will revert to show the time of day.

The oven and the clock oven control functions can now be used normally.

Cooking using the timer

The timer can be used to turn just one oven or both on and off automatically. The start and stop time must be the same for both ovens but different cooking temperatures can be set.

If you want to turn one of the ovens on at the same time as the timer is set for automatic cooking, you must wait until the timer has turned on the oven/ ovens first. Then you can adjust either of them manually in the normal way.

You can set the oven to turn on any time over the following 24 hour period

If you want to cook more than one dish, choose dishes that require approximately the same time. However, dishes can be 'slowed down' slightly by using small containers and covering them with aluminium foil, or 'speeded up' slightly by cooking smaller quantities or placing in larger containers.

Very perishable foods such as pork or fish should be avoided if a long delay period is planned, especially in hot weather.

*Don't place warm food in the oven.
Don't use an oven already warm.
Don't use if an adjoining oven is warm.*

Avoid using wine or beer if there is a delay period, as fermentation may take place.

To avoid curdling, cream should be added to dishes just before serving.

Fresh vegetables, which may discolour during a delay period, should be coated in melted fat or immersed in a water and lemon juice solution.

Many frozen foods are ideal for delayed cooking and can be placed in the oven while still frozen.

Fruit pies, custard tarts or similar wet mixtures on top of uncooked pastry are only satisfactory if there is a short delay period. Dishes containing leftover cooked meat or poultry should not be cooked automatically if there is a delay period.

*Whole poultry must be thoroughly defrosted before placing in the oven.
Check that meat and poultry are fully cooked before serving.*

Oven cooking

The wire shelves should always be pushed firmly to the back of the oven.

Baking trays meat tins etcetera should be placed level centrally on the oven's wire shelves. Keep all trays and containers away from the sides of the oven, as overbrowning of the food may occur.

For even browning, the maximum recommended size for a baking tray is 340 mm by 340 mm.

Cooking high moisture content foods can create a 'steam burst', when the oven door is opened. When opening the oven stand well back and allow any steam to disperse.

When the oven is on, don't leave the door open for longer than necessary, otherwise the knobs may get very hot.

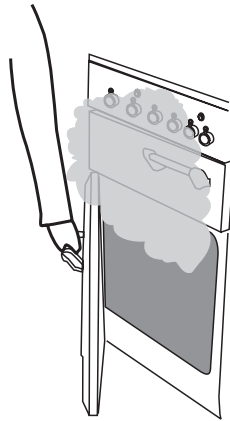

- Always leave a 'fingers width' between dishes on the same shelf. This allows the heat to circulate freely around them.
- The Cook & Clean oven liners (see *Cleaning your cooker*) work better when fat splashes are avoided. Cover meat when cooking.



- To reduce fat splashing when you add vegetables to hot fat around a roast, dry them thoroughly or brush lightly with cooking oil.
- Sufficient heat rises out of the oven while cooking to warm plates in the grill compartment.
- If you want to brown the base of a pastry dish, preheat a baking tray for 15 minutes before placing the dish in the centre of the tray.
- Where dishes may boil and spill over during cooking, place them on a baking tray.

Oven shelves

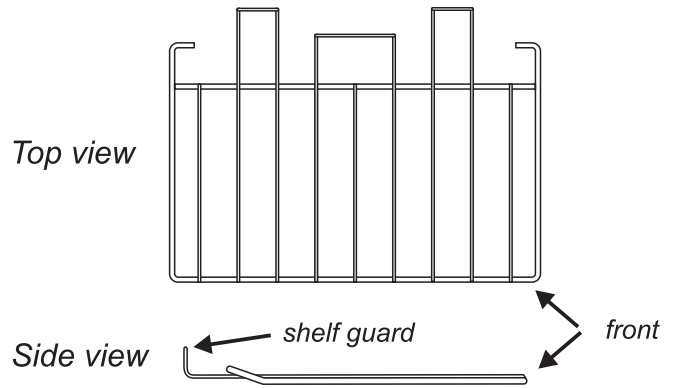

the shelf guard should be at the back pointing upwards

As well as the flat shelves some models are supplied with a drop shelf. The drop shelf increases the possibilities for oven shelf spacing.

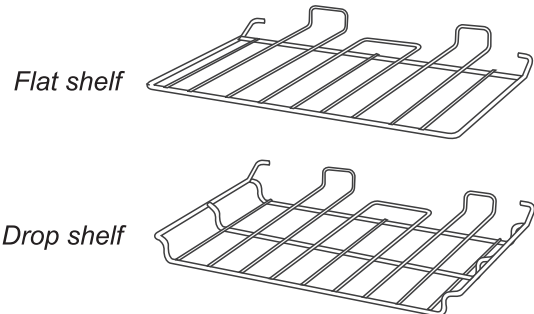

The oven shelves can be easily removed and refitted.

Pull the shelf forward until the back of the shelf is stopped by the shelf stop bumps in the oven sides.

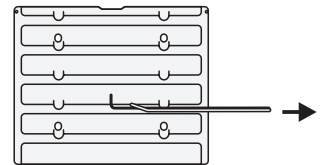

Lift up the front of the shelf so the back of the shelf will pass under the shelf stop and then pull the shelf forward.

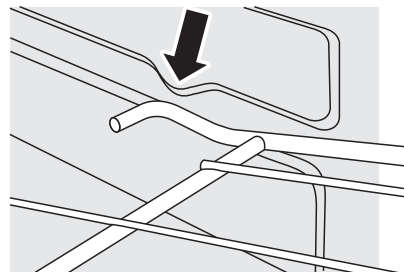
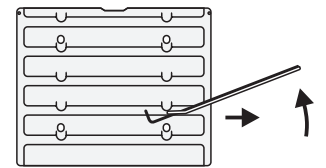

To refit the shelf, line up the shelf with a groove in the oven side and push the shelf back until the ends hit the shelf stop. Lift up the front so the shelf ends clear the shelf stops, and then lower the front so that the shelf is level and push it fully back.

The Handyrack

The maximum weight that can be held by the Handyrack is 5.5kg (12lb). It should only be used with the supplied meat tin, which is designed to fit the Handyrack. Any other vessel could be unstable.

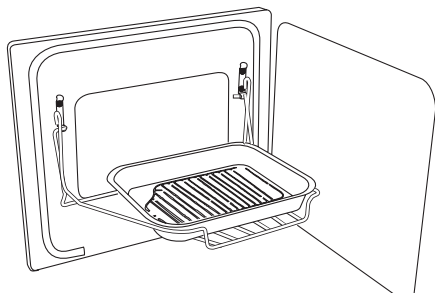

The Handyrack fits to the left hand oven door only. Food cooking on it is easy to attend to, because it's accessible when the door is open. It can be fitted at two different heights. One of the oven shelves must be removed and the other positioned to suit.

When the Handyrack is used in its highest position, other dishes can be cooked on the bottom shelf position of the oven or standing on the base of the oven

When the Handyrack is used in its lowest position, other dishes can be cooked on the second shelf position of the oven or standing on the base of the oven.

To fit the Handyrack, locate one side of it on the door bracket.

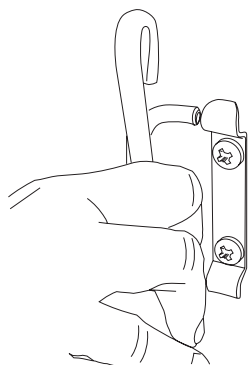
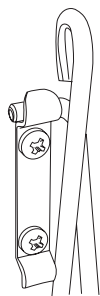

Then spring the other side out to clip it onto the other bracket.

Oven light

◀ oven light ▶



Press the appropriate button to turn on one of the oven lights.

If one of the oven lights fail, turn off the power supply before you change the bulb. See the 'Troubleshooting' section for details on how to change an oven light bulb.

The Browning Element

The Browning Element is positioned in the top of the left hand oven. It can be used at the end of a normal cooking period to give extra browning to au gratin dishes or give a crisper finish to meat.

After the normal cooking is finished turn the left hand oven thermostat knob clockwise to the browning position, indicated by (•••••) on the fascia panel.

Only the browning element will operate when the thermostat is turned to this position. The top and base cooking elements will automatically switch off.

Storage

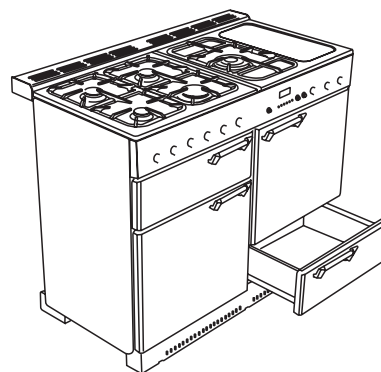

The bottom drawer is for storing oven trays and other cooking utensils. It can get very warm, don't store anything in it that may melt or catch fire. The drawer can be removed completely by pulling it right out and up.

Oven cooking guide

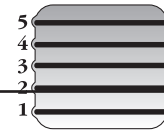

Food	LH Convection Oven		RH Fan Oven	
	Temperature	Shelf Position	Temperature	Approximate Cooking Time
FISH				
	190°C	3	180°C	Fillets 15-20mins.
	190°C	3	180°C	Whole 10mins.per 500g + 10mins.
	190°C	3	180°C	Steaks according to thickness.
ROAST MEATS				
Beef with bone	160°C	2-3	150°C	20-25mins. per 500g + 20-25mins.
	200°C	2-3	190°C	15-20mins. per 500g + 15-20mins.
Beef without bone	160°C	2-3	150°C	30-35mins. per 500g + 30-35mins.
	200°C	2-3	190°C	20-25mins. per 500g + 20-25mins.
Lamb	160°C	2-3	170°C	30-35mins. per 500g + 30-35mins.
	200°C	2-3	190°C	25-35mins. per 500g + 25-30mins.
Pork	160°C	2-3	150°C	35-40mins. per 500g + 35-40mins.
	200°C	2-3	190°C	25-30mins. per 500g + 25-30mins.
Stuffed and rolled - Add approx. 10 mins. per 500g to above cooking times or cook at 200°C for 20mins. then 160°C for remainder.				
THOROUGHLY THAW FROZEN JOINTS AND POULTRY BEFORE COOKING.				
POULTRY				
Chicken	160°C	2-3	150°C	20-25mins. per 500g + 20-25mins.
	200°C	2-3	190°C	15-20mins. per 500g + 15-20mins.
Turkey	160°C	2	150°C	20-25mins. per 500g + 20-25mins.
	200°C	2	190°C	15-20mins. per 500g + 15-20mins.
Stuffed Poultry - Cook at 200°C or at 200°C for 20mins. then 160°C for remainder. Prepacked (fresh or frozen) follow packers cooking times				
CASSEROLE	140-150°C	2-3	140°C	2-4hrs according to recipe
YORKSHIRE PUDDING	220°C	4	200°C	Large tin 30-35mins. Individual 10-20mins.
CAKES				
Very Rich Fruit	140°C	2	140°C	45-50mins. per 500g mixture
Rich fruit (180mm)	150°C	2	145°C	2½-3hrs.
Madeira (180mm)	160°C	2	150°C	80-90mins.
Queen Cakes	190°C	3 & 5 or 3	180°C	15-25mins.
Scones	220°C	2 & 4 or 3	210°C	10-15mins.
Victoria Sandwich	180°C	2 & 4 or 3	170°C	20-30mins.
PASTRIES				
Plate Tart	200°C	2 & 4	190°C	45-50mins. Interchange after 25mins.
Fruit Pie	200°C	2 & 4	190°C	35-40mins.
Tartlets	200°C	4	190°C	15-20mins. according to size.
Puff Pastry	220°C	2,3 or 4	200°C	20-40mins. according to size.
BREAD	220°C	2 & 4	200°C	20-30mins.
MERINGUES	110°C	3	100°C	2-2½hrs
PUDDINGS				
Baked Egg Custard	160°C	3	150°C	45mins.-1hr.
Baked sponge pudding	190°C	3	180°C	40-45mins.
Milk pudding	140-150°C	3	150°C	2-3hrs.

500g is approximately 1lb (1lb 2oz)

The oven control settings and cooking times given in the table opposite are intended to be used only as a guide. Individual tastes may require the temperature to be altered to provide a preferred result.

When baking in the right hand fanned oven, use the minimum cooking time shown in the table. Food is cooked at lower temperature in a fan oven than in a conventional oven. When using recipes, reduce the temperature by 10°C and the cooking time by 5-10 minutes. The temperature in the fanned oven does not vary with height in the oven - so you can use any shelf.

Always leave at least one runner space between shelves when 2 tier cooking. Place baking trays, individual cake tins or baking dishes centrally on the oven shelf. For best results pre-heat the oven until the oven indicator light goes out.

Cleaning your cooker

Essential information

Before thorough cleaning isolate the electricity supply. Remember to switch on the electricity supply before use.

Never use paint solvents, washing soda, caustic cleaners, biological powders, bleach, chlorine based bleach cleaners, coarse abrasives or salt. Don't mix different cleaning products - they may react together with hazardous results. Recommended cleaning materials are shown in the table at the end of this section. Do not use a steam cleaner on your cooker.

If you want to move your cooker for cleaning, see the section called 'Moving your cooker'.

All parts of the cooker can be cleaned with hot soapy water - **but take care that no surplus water seeps into the appliance.**

For cleaning materials see the 'Cleaning Table' at the end of this section.

Hotplate burners

Some models have a separate trim ring, which fits on the burner head.

The burner heads and caps can be removed for cleaning. Make sure they are absolutely dry before replacing.

The LH hotplate

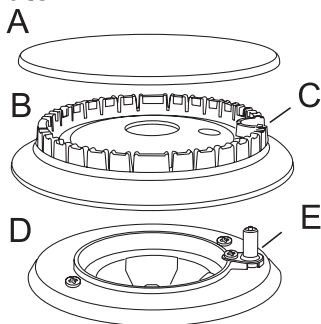

A cap, B head, C notch, D base, E electrode

When refitting the burner head, make sure that the notch lines up with the electrode or hole in the base. Check that the burner head is level and that the cap is fitted centrally on the burner head.

The Wok burner

The Wok burner is a little more complicated but it also can be taken apart for cleaning.

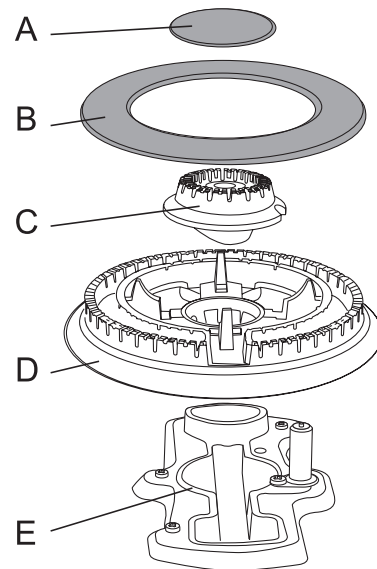

Wok burner

- A inner burner cap, B outer burner cap
C inner burner head D outer burner head
E Wok burner base

When reassembling the Wok burner, turn over the large base ring and find the 'D' shaped area.

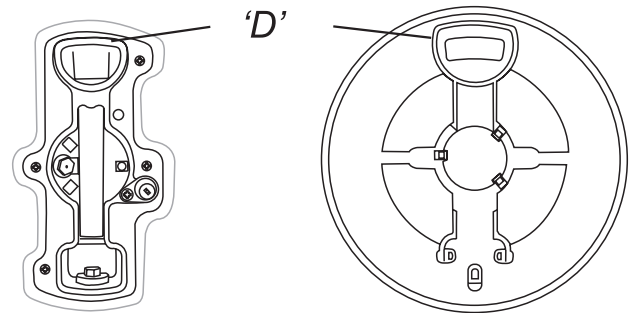

burner base

underside of burner head

Turn the head until the 'D' matches the one on the burner base. Turn the head over and place it on the burner base. To fit the small inner burner, find the larger electrode notch in the burner rim. Line this up with the white ignition electrode and place the inner burner on the large base ring.

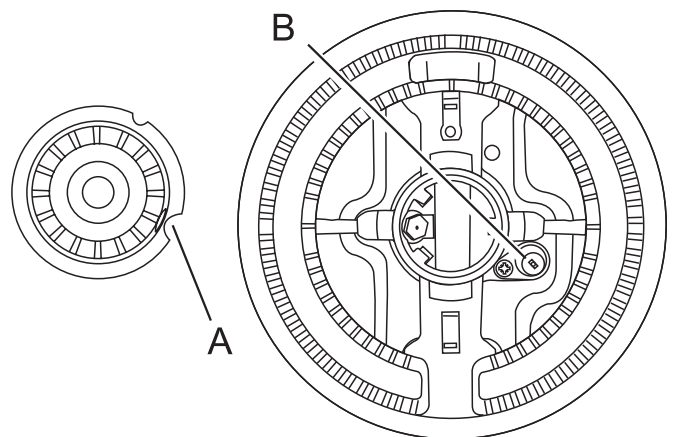

A electrode notch

B ignition electrode

Now fit the two trim rings, making sure that they are sitting down properly.

Griddle

Always clean the griddle after use. Allow to cool completely before removing. Immerse the griddle plate in hot soapy water. Use a soft cloth or, for stubborn stains, a nylon washing up brush.

NEVER USE CAUSTIC OR ABRASIVE CLEANERS AS THESE WILL DAMAGE THE SURFACE.

If the griddle is washed in a dishwasher then some dishwasher residue may appear on the back. This is normal and will not affect the performance of your griddle.'

Control Panel and Doors

The control panel and control knobs should only be cleaned with a soft cloth wrung out in clean hot soapy water - **but take care that no surplus water seeps into the appliance.** Wipe with a clean dampened cloth then polish with a dry cloth. The oven doors should only be cleaned with a soft cloth wrung out in clean hot soapy water.

Grill

The grill pan and grid should be washed in hot soapy water. After grilling meats or any foods that soil, leave to soak for a few minutes in the sink immediately after use. Stubborn particles may be removed from the grid by using a nylon brush.

The Ovens

The ovens have panels which have been coated with a special enamel that partly cleans itself. This does not stop all marks on the lining, but helps to reduce the amount of manual cleaning needed.

The Cook & Clean panels work better above 200°C. If you do most of your cooking below this temperature, occasionally remove the panels and wipe with a lint free cloth and hot soapy water. The panels should then be dried and replaced and the oven heated at 200°C for about one hour. This will ensure the Cook & Clean panels are working effectively.

Don't use steel wool (Brillo) or any other materials that will scratch the surface. Don't use oven cleaning pads.

Removing the Oven Linings

Some of the lining panels can be removed for cleaning and for cleaning behind. Remove the shelves first.

On some models the right hand fanned oven has a removable oven roof - if fitted slide the roof liner forward and remove.

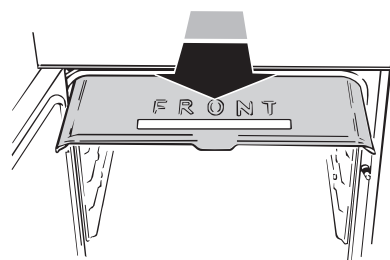

The side panels of either oven can be removed. Each side of the oven is fixed with four fixing screws. You don't have to remove the screws to remove the oven linings. Lift each side panel upwards and they will slide off the screws. Then pull them forwards.

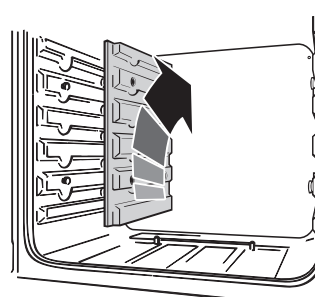

Once the linings are removed, the oven enamel interior can be cleaned.

Cleaning Table

Hotplate

Part	Finish	Recommended Cleaning Method
Hotplate Top	Enamel or Stainless Steel	Hot soapy water, soft cloth. Any stubborn stains remove gently with a nylon scourer.
Pan Supports, Wok Cradle (some models only)	Enamel coated Cast Iron or Stainless Steel	Cif Cream Cleaner- <i>Faberge Lever</i> and a nylon scourer. Dishwasher.
Warming Zone (some models only)	Toughened Glass	Hot soapy water, cream cleaner/scourer if necessary.
Burner Caps	Enamel	Cream cleaner, nylon scourer. Dishwasher
Burner Trim Rings (some models only) and Burner Head	Aluminium	Cif or other cream cleaner with a soft cloth. Be careful not to be over vigorous.
Griddle Plate (some models only)	Non-Stick Surface	Allow to cool. Wash in hot soapy water. Do not use abrasive cleaners/scourers. Dishwasher.

Outside of cooker

Part	Finish	Recommended Cleaning Method
Door, Door surround and Storage Drawer exterior.	Enamel or paint	Hot soapy water, soft cloth. Any stubborn stains, remove gently with a liquid detergent.
	Stainless Steel	E Cloth (Comet) or Vileda Microfibre Plus All Purpose Cloth <i>Freudenberg Household Products LP</i> (supermarket)
Sides and Plinth	Painted surface	Hot soapy water, soft cloth
Splashback/Rear Grille	Enamel or Stainless Steel	Hot soapy water, soft cloth. Cream cleaner, with care, if necessary.
Control panel	Paint, Enamel or Stainless Steel	Warm soapy water. Do not use abrasive cleaners on lettering.
Control Knobs/Handles	Plastic/ Chrome	Warm soapy water, soft cloth.
Oven Door Glass/Glass Lid	Toughened glass	Hot soapy water, cream cleaner/scourer if necessary.

Oven and Grill

Part	Finish	Recommended Cleaning Method
Sides, floor & roof of oven - NOT COOK & CLEAN OVEN PANELS (see below)	Enamel	Any proprietary oven cleaner that is suitable for enamel. CAUTION: CORROSIVE/CAUSTIC OVEN CLEANERS - FOLLOW MANUFACTURERS INSTRUCTIONS. Do not allow contact with the oven elements.
Cook & Clean Oven Panels (some models only)	Special enamel that partly cleans itself	This surface cleans itself at 200°C and above, or the panels can be removed and washed with hot soapy water and a nylon brush. (see 'The Ovens' in 'Cleaning your cooker')
Oven Shelves, Handyrack, Grill Trivet, Handygrill rack	Chrome	An oven interior cleaner that is suitable for chrome. Soap filled pad. Dishwasher.
Grill Pan/Meat Tin (some models only)	Enamel	Hot soapy water. Soap filled pad (Brillo). Dishwasher.

Cleaners listed are available from Supermarkets or electrical retailers as stated. Cleaner manufacturer in Italics

For enameled surfaces use a cleaner that is approved for use on vitreous enamel. The vitreous enamel association has a list of approved cleaners. Contact them via their website www.ive.org.uk or telephone: 01543 450596.

Regular cleaning is recommended. For easier cleaning, wipe up any spillages immediately.

To help keep your oven clean, cover meat when roasting, with foil or use a roasting bag. Brush vegetables with fat before placing around the meat.

Moving your cooker

Switch off the electricity supply.

The cooker is heavy, two people may be required to move it. The cooker is fitted with one roller at the front and two at the back. There are also two screw down levelling feet at the front.

The front roller, designed for moving the cooker can be wound down. The levelling tool that controls this roller is in the storage drawer compartment.

Remove the storage drawer (by pulling it right out and lifting it up slightly) and you should see the levelling tool.

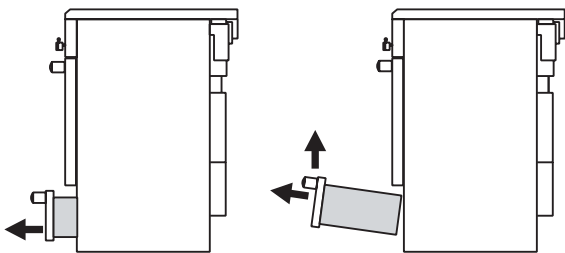

Your installer may not have left the levelling tool in place. If not, locate it as shown. If you cannot find the levelling tool, contact your installer. See the Installation section of these instructions where your installer should have written their contact details.

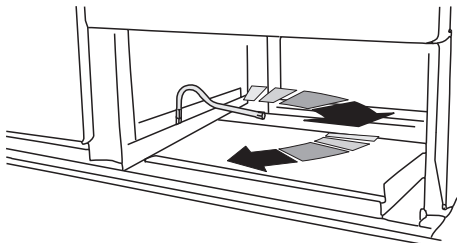

Turn the levelling tool clockwise, two full (180°) turns. It will be stiff. The front of the oven will rise slightly as the roller drops down.

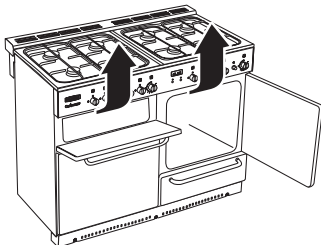

Open the grill door and right hand oven door so that you can get a good grip on the bottom of the fascia panel as you move the oven.

Do not move the oven by pulling the hand rail, door handles or knobs.

Move the oven a bit at a time, checking behind it to make sure the gas hose is not caught. Make sure both electricity and gas cables have sufficient slack to move the cooker forward as you go along.

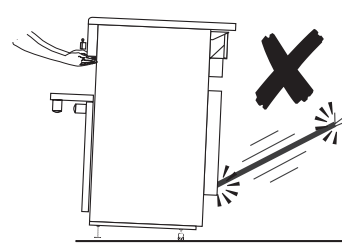

If a stability chain is fitted, release it as you ease the cooker out.

When you replace the cooker, wind it down off the rollers by turning the levelling tool anti-clockwise. This is important. It will stop the cooker moving accidentally, while in use.

When you replace the cooker, wind it down off the rollers by turning the levelling tool anti-clockwise. This is important. It will stop the cooker moving accidentally, while in use.

Troubleshooting

Hotplate ignition or hotplate burners faulty

Is the power on? Is the clock illuminated? If not there maybe something wrong with the power supply.

See 'power supply' section further on.

Are the sparker (ignition electrode) or burner slots blocked by debris? Is the burner trim correctly located? Are the burner caps correctly located?

See the section entitled 'Cleaning'

Hotplate burners will not light

If only one or all the hotplate burners will not light, make sure that the parts have been replaced correctly after wiping or removing for cleaning.

Check that there is not a problem with your gas supply. You can do this by making sure that other gas appliances you may have are working.

Do the burners spark when you push the button? If not check the power is on - is the clock illuminated?

A crack has appeared in the Warmer plate's surface

Disconnect the cooker immediately from the power supply and arrange for its repair. Don't use the cooker until after the repair. See the HELP leaflet for how to contact a service person.

Grill not cooking properly

Are you using the pan and trivet supplied with the cooker? Is the pan being used on the runners, not the floor of the compartment? Is the grill pan pushed fully back to stop?

Steam is coming from the oven

During cooking, food naturally produces steam, particularly when cooking foods with high water content (e.g. oven chips). There may be some steam visible at the grille at the rear of the hotplate. This is perfectly normal. Steam can condense to water droplets on the cool outer trim or the oven door. It may be necessary during cooking to wipe away any moisture with a soft cloth. This will also help to prevent soiling and discolouration of the oven exterior by cooking vapours.

Take care when opening the oven door as there may be a momentary puff of steam when the oven door is opened. Stand well back and allow any steam to disperse.

The oven fan is noisy

The note of the oven fan may change as the oven heats up - this is perfectly normal.

The knobs get hot when I use the oven or the grill, can I avoid this?

Yes, this is caused by heat rising from the oven or the grill, and heating them up. Don't leave the oven door open. Make sure that the grill pan is pushed right back to the 'back stop' when grilling.

Food is cooking too slowly, too quickly, or burning

Cooking times may differ from your previous oven. Check that you are using the recommended temperatures and shelf positions. See the 'Oven cooking guide' section of these instructions. The oven control settings and cooking times are intended to be used only as a guide. Individual tastes may require the temperature to be altered either way, to get the results you want. Try cooking at a higher temperature setting.

The oven is not cooking evenly

Do not use a tin or tray larger 340mm x 340mm.

If you are cooking a large item, be prepared to turn it round during cooking.

If two shelves are used, check that space has been left for the heat to circulate. When a baking tray is put into the oven, make sure it is placed centrally on the shelf.

Check that the door seal is not damaged and that the door catch adjusted so that the door is held firmly against the seal.

NB the seal is intended to have a gap at the bottom of the door

A dish of water when placed on the shelf should be the same depth all over. (For example, if it is deeper at the back, then the back of the cooker should be raised up or the front lowered). If the cooker is not level arrange for your supplier to level it for you.

Oven not coming on when turned on manually

Is the power on? Is the clock illuminated? If not there may be something wrong with the power supply. Is the cooker supply on at the isolator switch? Is the clock flashing 0.00? If so set it to the correct time of day. Has the Timer been set to AUTO by mistake. If AUTO is showing on the clock display, press the 'cook period' button and reduce any set cooking time showing to 0.00, with the (+) and (-) buttons. Press the  button twice.

Is the key symbol (Ⓚ) showing in the display? See the Clock section of the instructions for more information on the key lock feature of the clock.

Oven not coming on when automatic cooking

Timer set correctly but oven knob left OFF by mistake?

Is the key symbol (Ⓚ) showing in the display? See the Clock section of the instructions for more information on the key lock feature of the clock.

Oven temperature getting hotter as the cooker gets older

If turning the knob down has not worked or only worked for a short time then you may need a new thermostat. This should be fitted by a service person.

The oven light is not working

The bulb has probably blown. You can buy a replacement bulb (which is not covered under the guarantee) from a good electrical shop. Ask for an Edison screw fitting 15w 230v lamp, FOR OVENS. It must be a special bulb, heat resistant to 300 °C.

Open the oven door and remove the Handyrack (if fitted) and oven shelves.

Turn off the power supply.

Unscrew the bulb cover by turning anticlockwise. Unscrew the old bulb. Screw in the new bulb, screw back the bulb cover. Turn on the electricity supply and check that the bulb now lights.

Current Operated Earth Leakage Breakers

Where the cooker installation is protected by a 30 milliamp sensitivity residual current device (RCD), the combined use of your cooker and other domestic appliances may occasionally cause nuisance tripping. In these instances the cooker circuit may need to be protected by fitting 100mA device. This work should be carried out by a qualified electrician.

Power failure

In the event of a failure in the electrical supply the hotplate may be lit using a match.

If there is an installation problem and I don't get my original installer to come back to fix it who pays?

You do. Service organisations will charge for their call outs if they are correcting work carried out by your original installer. It's in your interest to track down your original installer.

What cleaning materials are recommended for the cooker?

See the 'Cleaning' section for recommended cleaning materials. We do not recommend Mr. Muscle, as it contains chemicals that may damage the surfaces of your cooker.



General Safety Instructions

In the UK the cooker must be installed by a Gas Safe registered engineer.

The installation must be in accordance with the installation instructions and comply with the relevant regulations and also the local gas and electricity supply companies' requirements.

If you smell gas

Don't turn electric switches on or off.

Don't smoke

Don't use naked flames

Do turn off the gas at the meter or cylinder

Do open doors and windows to get rid of the gas

Call your gas supplier.

If you are using natural gas in the UK ring the National Grid on:

0800 111 999

DO NOT SPRAY AEROSOLS IN THE VICINITY OF THIS APPLIANCE WHILE IT IS IN OPERATION.

WHERE THIS APPLIANCE IS INSTALLED IN MARINE CRAFT OR IN CARAVANS, IT SHALL NOT BE USED AS A SPACE HEATER.

This appliance is designed for domestic cooking only. Use for any other purpose could invalidate any warranty or liability claim.

The use of a gas cooking appliance results in the production of heat and moisture in the room in which it is installed. Ensure that the kitchen is well ventilated: keep natural ventilation holes open or install a mechanical ventilation device, (mechanical extractor hood).

Prolonged intensive use of the appliance may call for additional ventilation, for example opening a window, or more effective ventilation, for example increasing the level of mechanical ventilation where present.

The cooker should be serviced by an Authorised Person and only approved spare parts used. Have the installer show you the location of the cooker control switch. Mark it for easy reference. Always allow the cooker to cool and then switch

off at the mains and before cleaning or carrying out any maintenance work, unless specified otherwise in this guide.

All parts of the cooker become hot with use and will retain heat even after you have stopped cooking.

Take care when touching cooker, to minimize the possibility of burns, always be certain that the controls are in the OFF position and that it is cool before attempting to clean the cooker. Avoid touching heating elements.

Use dry oven gloves when applicable - using damp gloves might result in steam burns when you touch a hot surface. Never operate the cooker with wet hands.

Do not use a towel or other bulky cloth in place of a glove. They might catch fire if they touch a hot surface.

Clean with caution. If a wet sponge or cloth is used to wipe spills on a hot surface, be careful to avoid steam burns. Some cleansers can produce noxious fumes if applied to a hot surface.

Do not use unstable saucepans and position the handles away from the edge of the hotplate.

The appliance is not intended for unsupervised use by young children or infirm persons. Babies, toddlers and young children should not be allowed near the cooker at any time. They should never be allowed to sit or stand on any part of the appliance. Teach them not to play with controls or any other part of the cooker.

Never store anything of interest to children in cabinets above a cooker - children climbing on the cooker to reach them could be seriously injured.

Clean only parts listed in this guide.

In the interests of hygiene and safety the cooker should be kept clean at all times as a build up in fats and other food stuff could result in a fire.

Always keep combustible wall coverings or curtains etc. a safe distance away from your cooker. For more detail see the Installation section of these instructions.

Do not store or use flammable liquids or materials in the vicinity of this appliance. This includes some cleaning solvents and chemicals used in dry cleaning.

Do not use water on grease fires. Never pick up a flaming pan. Turn the controls off. Smother a flaming pan on a surface unit by covering the pan completely with a well fitting lid or baking tray. If available use a multipurpose dry chemical or foam-type fire extinguisher.

Never leave the hotplate unattended at high heat settings. Pans boiling over can cause smoking and greasy spills may catch on fire.

Never wear loose-fitting or hanging clothes while using the appliance. Be careful when reaching for items stored in cabinets over the hotplate. Flammable material could be ignited if brought in contact with a hot surface unit and may cause severe burns.

Take great care when heating fats and oils, as they will ignite if they get too hot.

Use a deep fat thermometer whenever possible to prevent overheating fat beyond the smoking point.

Never leave a chip pan unattended. Always heat fat slowly, and watch as it heats. Deep fry pans should be only one third full of fat. Filling the pan too full of fat can cause spill over when food is added. If you use a combination of oils or fats in frying, stir them together before heating, or as the fats melt.

Foods for frying should be as dry as possible. Frost on frozen foods or moisture on fresh foods can cause hot fat to bubble up and over the sides of the pan. Carefully watch for spills or overheating of foods when frying at high or medium high temperatures. Never try to move a pan of hot fat, especially a deep fat fryer. Wait until the fat is cool.

When the grill is on, do not use the top of the flue (the slot along the back of the cooker) for warming plates, dishes, drying tea towels or softening butter.

When using an electrical appliance near the hotplate, be sure that the cord of the appliance does not come into contact with the hotplate.

If you find a crack in the Warmer surface immediately disconnect the appliance from the supply and arrange for its repair.

Take care that no water seeps into the appliance

Only certain types of glass, glass-ceramic, earthenware or other glazed containers are suitable for hotplate cooking; others may break because of the sudden change in temperature.

Do not allow anyone to climb, stand or hang on any part of the cooker.

Do not use aluminium foil to cover shelves, linings or the oven roof.

Make sure that your kitchen is well ventilated at all times. Use extractor fans or hoods when fitted.

Never heat unopened food containers. Pressure build up may make container burst and cause injury.

The cooker is designed for cooking foods only and must not be used for any other purpose.

The oven should NOT be used for heating the kitchen, not only does this waste fuel but the control knobs may become overheated.

When the oven is on DO NOT leave the oven door open for longer than necessary.

The specification of this cooker should not be altered.

This appliance is heavy, take care when moving it.

When the cooker is not in use ensure that the control knobs are in the off position.

Installation

You must be aware of the following safety requirements & regulations

Prior to installation, ensure that the local distribution conditions (nature of the gas and gas pressure) and the adjustment of the appliance are compatible.

This appliance shall be installed in accordance with the regulations in force and only in a well ventilated space. Read the instructions before installing or using this appliance.

In the UK the regulations and standards are as follows:-

In your own interest and that of safety, it is law that all gas appliances be installed by competent persons. Gas Safe registered installers undertake to work to safe and satisfactory standards. Failure to install the appliance correctly could invalidate any warranty or liability claims and lead to prosecution.

This appliance should not be installed in a boat or caravan.

The cooker must be installed in accordance with:-

- ▶ All relevant British Standards / Codes of Practice, in particular BS 5440 Part 2 2000,
- ▶ or Natural Gas - BS 6172 : 1990 and BS 6891 : 1998
- ▶ For LP Gas - BS 5482-1:1994 (when the installation is in a permanent dwelling). This appliance should not be installed in a boat or caravan.
- ▶ The Gas Safety (Installation and Use) regulations 1998.
- ▶ The relevant Building / IEE regulations.

Provision of Ventilation

This appliance is not connected to a combustion products evacuation device. Particular attention shall be given to the relevant requirements regarding ventilation.

In the UK

The room containing the cooker should have an air supply in accordance with BS 5440 Part 2 : 2000. All rooms require an openable window or equivalent, while some rooms require a permanent vent in addition to the openable window. The cooker should not be installed in a bedsitting room with volume less than 20m³. If it is installed in a room of volume less than 5m³ an air vent of effective area 100cm² is required; if it is installed in a room of volume between 5m³ and 10m³, an air vent of effective area 50cm² is required; while if the volume exceeds 11m³, no air vent is required.

If there are other fuel burning appliances in the same room, BS 5440 Part 2 : 2000 should be consulted to determine the requisite air vent requirements.

Location of Cooker

The cooker may be installed in a kitchen/kitchen diner but NOT in a room containing a bath or shower.

NOTE:

An appliance for use on LPG shall not be installed in a room or internal space below ground level. e.g. in a basement.

Conversion

All models are supplied set for use on group H natural gas. A conversion kit from NG to LP gas is supplied with the cooker.

For conversion, see the instructions that are supplied with the conversion kit. After converting the appliance please attach the Gas Conversion sticker over the appropriate area of the data badge, this will identify the gas type the appliance is now set for.

This appliance is designed for domestic cooking only. Use for any other purpose could invalidate any warranty or liability claim.

Dear Installer

Before you start your installation, please complete the details BELOW.

If your customer has a problem relating to your installation they will be able to contact you easily.

Thank you

Installer's Name

Installer's Company

Installer's Telephone number

You will need the following equipment to complete the cooker installation satisfactorily

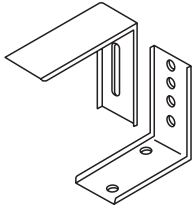
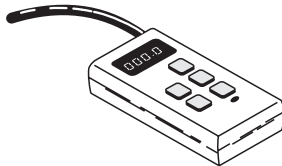
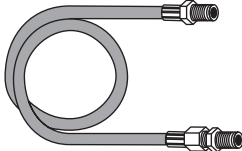
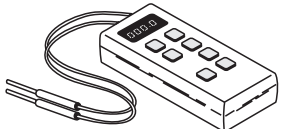
			
<p>STABILITY BRACKET If the cooker is to be supplied with gas through a flexible hose, a stability bracket or chain must be fitted.</p> <p>These are not supplied by with the cooker but are available at most builders merchants.</p>	<p>GAS PRESSURE TESTER It is important the gas pressure is set correctly</p>	<p>FLEXIBLE GAS HOSE Must be in accordance with the relevant standards. For LP Gas it should be suitable for LPG, capable of 50mbar pressure, 70°C temperature rise and carry a red stripe, band or label.</p> <p>A hose is not supplied by with the cooker.</p>	<p>MULTIMETER (for electrical checks) Make sure the installation is electrically safe.</p>

You will also need the following tools:

1. Electric drill
2. Masonry drill bit & Rawlplugs
(only required if fitting the cooker on a stone or concrete floor)
3. Steel tape measure
4. Cross head screwdriver
5. Flat head screwdriver
6. Spirit level
7. Pencil
8. Adjustable spanner
9. Screws for fitting stability bracket

Positioning the Cooker

The diagrams below show the minimum recommended distance from the cooker to nearby surfaces.

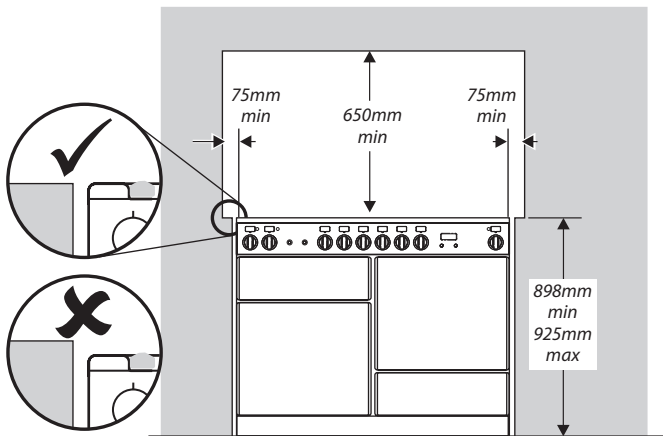

The hotplate surround should be level with, or above, any adjacent work surface. Above hotplate level a gap of 75mm should be left between each side of the cooker and any adjacent vertical surface.

For non-combustible surfaces (such as unpainted metal or ceramic tiles) this can be reduced to 25mm.

A minimum space of 650mm is required between the top of the hotplate and a horizontal combustible surface.

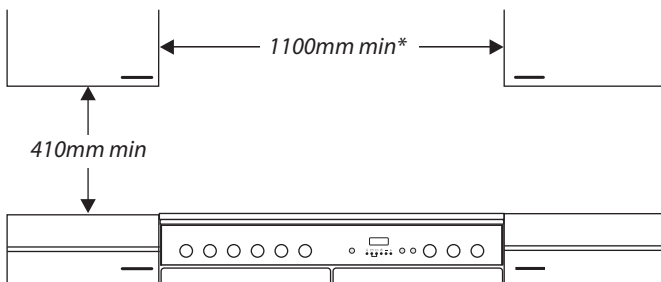

*Any cooker hood should be installed in accordance with the hood manufacturer's instructions.

Surfaces of furniture and walls at the sides and rear of the appliance should be heat, splash and steam resistant. Certain types of vinyl or laminate kitchen furniture are particularly prone to heat damage and discolouration. We cannot accept responsibility for damage caused by normal use of the cooker to any material that de-laminates or discolours at temperatures less than 65°C above room temperature.

For safety reasons curtains must not be fitted immediately behind the cooker.

We recommend a gap of 1110mm between units to allow for moving the cooker. If a flush fit is required, fit the cooker up to the unit at one side then fit the unit the other side. Do not box the cooker in; it must still be possible to move the cooker in and out for cleaning and servicing. The cooker should not be placed on a base.

Checking the parts

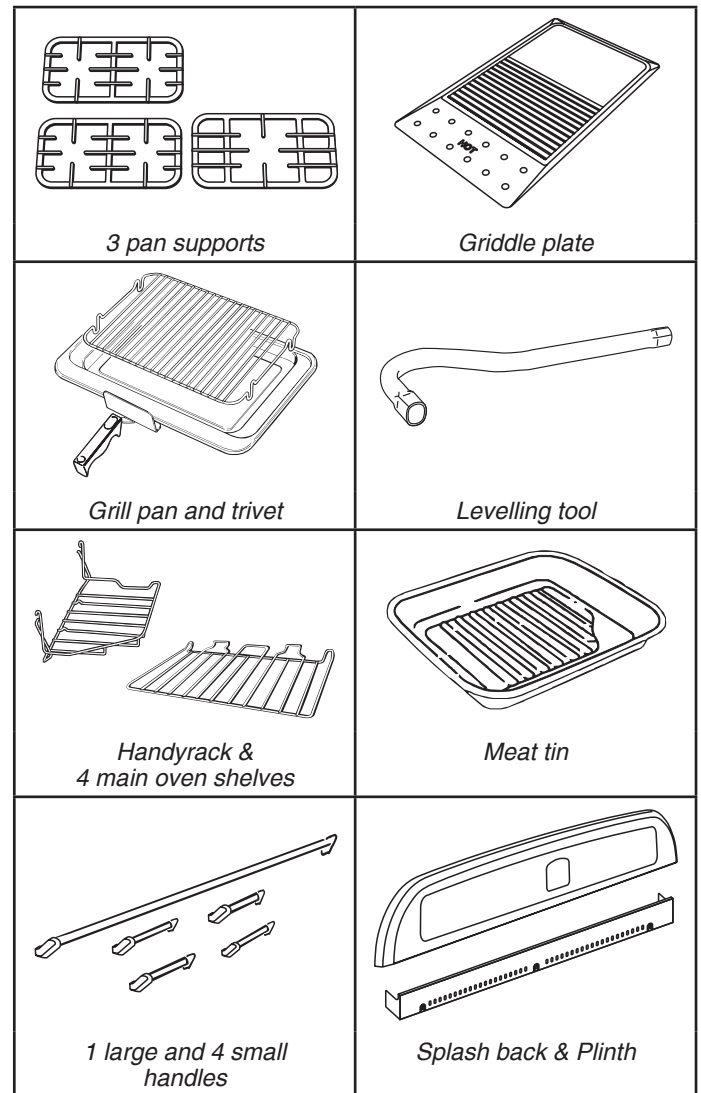

A clearance of 130mm is required if the cooker is near a corner of the kitchen to allow the oven doors to open.

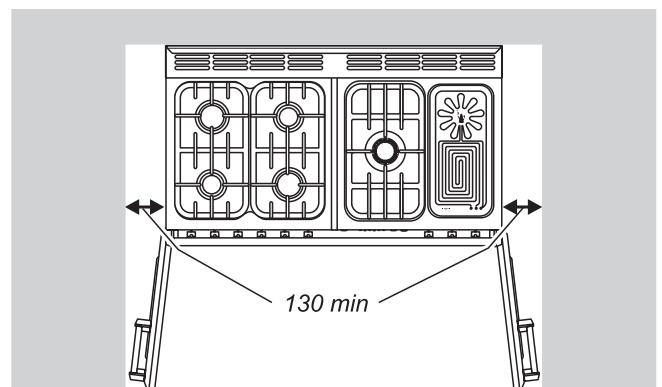

Unpacking the Cooker

Do not take any packaging off the cooker until it is directly in front of the place it is to be installed (unless it will not fit through a door in its outer packaging).

See the loose unpacking sheet.

Moving the Cooker

The cooker is very heavy. Take great care. We recommend two people manoeuvre the cooker. Ensure that the floor covering is firmly fixed, or removed to prevent it being disturbed when moving the cooker around. You will need the levelling tool.

From the back tilt the cooker forward and remove the rear half of the polystyrene base pack.

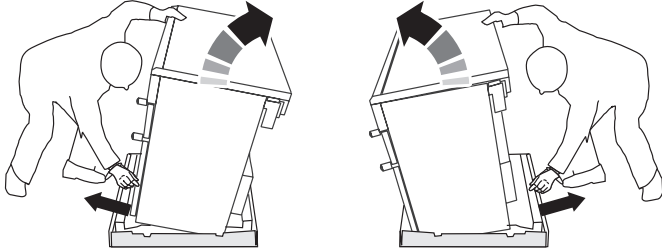

Repeat from the front and remove the front half of the poly base. Pull the drawer out to its furthest point. Lift it up and out.

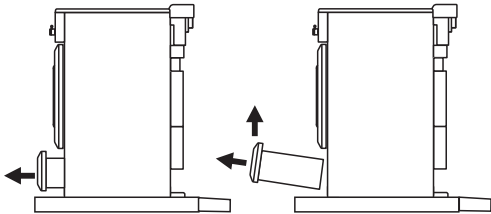

Fit the levelling tool on the rectangular adjuster as shown below.

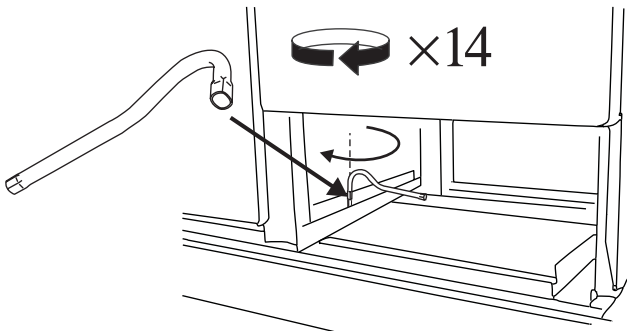

LOWER THE FRONT ROLLER by doing 14 complete (360°) turns clockwise. (This means turning and removing the levelling tool 56 times).

Now **LOWER THE TWO REAR ROLLERS**. First fit the levelling tool on the hexagonal adjusting nut as shown below.

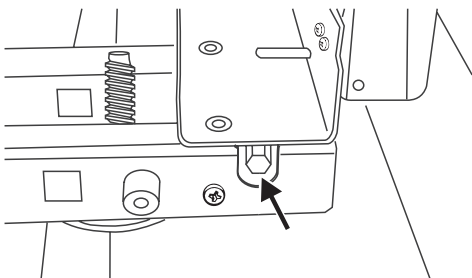

Make 10 complete (360°) turns clockwise. (This means turning and removing the levelling tool 20 times).

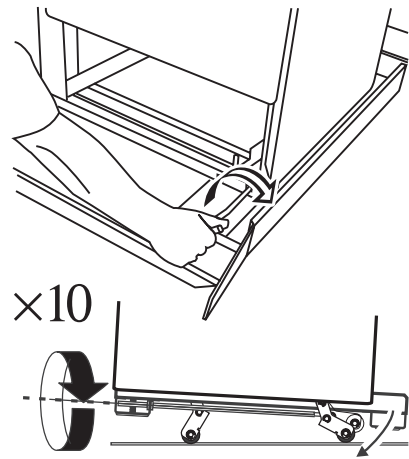

Make sure you lower **BOTH REAR ROLLERS**. There are two adjusting nuts, one for each roller, at both the front bottom corners of the cooker.

Unfold the rear edge of pack base tray. Carefully push the cooker backwards out of the base pack. Push the cooker close to its final position, leaving just enough space to get behind it.

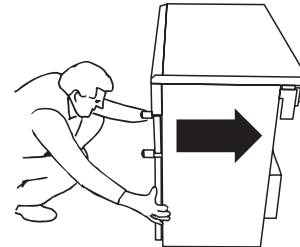

Levelling

You are recommended to use a spirit level on a shelf in one of the ovens to check for level.

Place the cooker in its intended position taking care not to twist it within the gap between the kitchen units as damage may occur to the cooker or the units.

The rollers can be adjusted to level the cooker. To adjust the height of the rear of the cooker use the levelling tool supplied to turn the adjusting nuts at the front bottom corners of the cooker.

Adjust the height of the front roller to level the cooker. Turn clockwise to raise the cooker and anticlockwise to lower.

When you are satisfied with the height and level raise the front of the cooker by one turn of the front roller adjuster. Screw down the front feet to meet the floor. Screw the front roller adjuster anticlockwise to raise the front roller so that the front of the cooker is supported on the feet, **not** the front roller, to prevent accidental movement of the cooker.

Leave the levelling tool on the adjuster with the handle of the tool facing the rear of the cooker, so that the customer can use it if they wish to move the cooker.

Replace the drawer by locating on side runners and push in.

Fit the Handles

Remove the 4mm Allen screws from the doors with the hexagon key tool. Use the screws to fit the door handles.

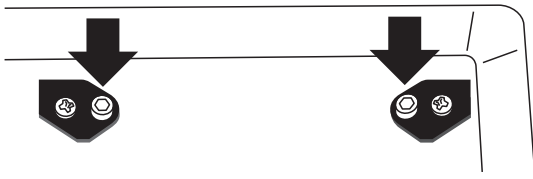

The handles should be above the fixings.

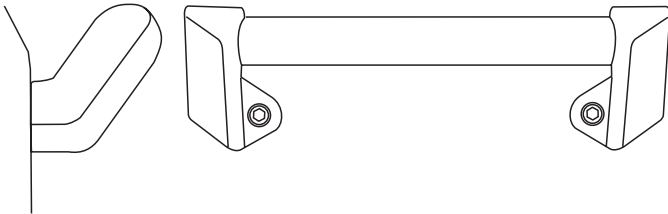

Remove the 4mm Allen screws from the top corners of the fascia and fix the front handrail in position.



Fitting the splashback (optional)

Remove the two fixing screws (3mm hexagonal socket head) and nuts that pass through the top of the rear flue grille. Hold the splash back in position. From the rear refit the 2 fixing screws and nuts.

Fitting a stability bracket

A stability bracket or chain (**not supplied by with the cooker**) should be fitted when the cooker is connected to a flexible gas supply.

When fitting a stability bracket read these instructions together with the leaflet supplied with the bracket.

1. Place the cooker in its intended position and level the cooker.
2. Draw a pencil line 100mm from the front edge of the levelling feet.
3. Mark the centre line for the bracket by measuring 550mm from the left hand side of the cooker.

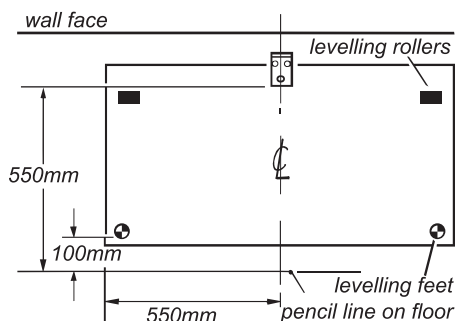

4. Lower the front roller and move the cooker forward.
5. Measure back from the pencil line 550mm to locate the front edge of the bracket. Fix the bracket to the floor.
6. Measure the height from floor level to engagement edge in back of cooker. Add 3mm to this dimension and assemble the stability bracket to this height. (i.e. from floor level to underside of the top member) and

ensure the bracket does not foul the oven burner assembly.

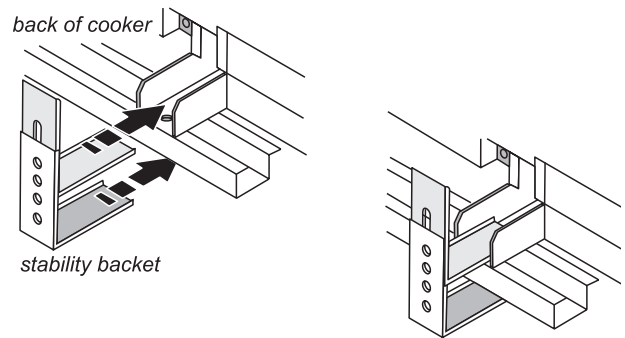

Gas Connection

A hose is not supplied by with the cooker. The Gas supply needs to terminate with a down facing bayonet. The rear cover boxes limit the position of the supply point.

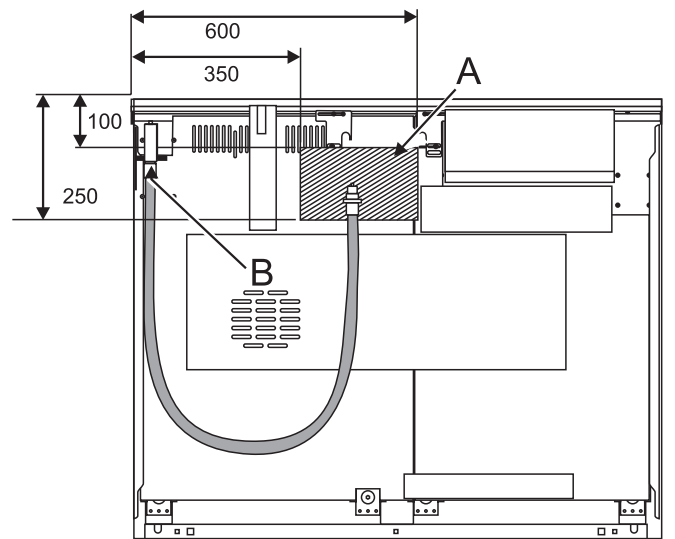

view from the rear

A position for gas supply connector

B appliance gas inlet

Because the height of the cooker can be adjusted and each connection is different it is difficult to give precise dimensions. Ideally the house supply bayonet should be in the shaded area shown in the diagram. Although a 900mm hose can be used, a 1250mm hose will allow slightly more flexibility in the positioning of the bayonet and make moving the cooker easier. The hose should be fitted so that both inlet and outlet connections are vertical so that the hose hangs downwards.

The connector is located just below the hotplate level at the rear of the cooker.

For Natural Gas the flexible hose must be in accordance with B.S.669.

For LP Gas it should be capable of 50mbar pressure, 70°C temperature rise and carry a red stripe, band or label.

If in doubt contact, your supplier.

Screw the threaded end of the hose into the gas inlet in the underside of the connector block on the back of the cooker.

After completing the gas connection, check the cooker is gas sound with a pressure test.

Pressure testing

The gas pressure can be measured at one of the LH hotplate burner injectors. Lift off a burner head. Fit the pressure gauge to the injector. Turn on the hotplate burner and turn on and light one of the other hotplate burners.

For Natural Gas cookers the pressure should be 20mbar.

For LP Gas cookers the pressure should be 29mbar for Butane

37mbar for Propane.

Reassemble burner top, making sure it is reassembled in the correct way on the burner body.

Electrical Connection

This appliance must be installed by a qualified electrician to comply with the relevant Institute of Electrical Engineers (I.E.E.) regulations and also the local electricity supply company requirements.

WARNING: THIS APPLIANCE MUST BE EARTHED

Note

The cooker must be connected to the correct electrical supply as stated on the voltage label on the cooker, through a suitable cooker control unit incorporating a double pole switch having a contact separation of at least 3mm in all poles. This cooker must not be connected to an ordinary domestic power point.

The cable size used should be between 6mm² and 10mm², twin and earth.

Access to the mains terminal is gained by removing the electrical terminal cover box on the back panel.

230VAC 50Hz

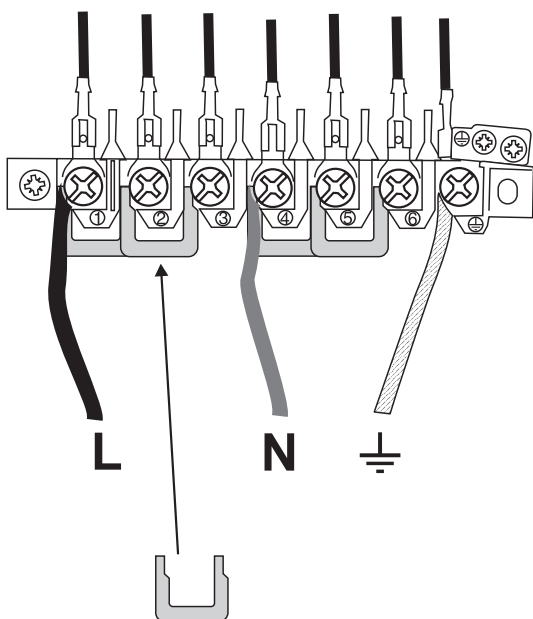

Single phase

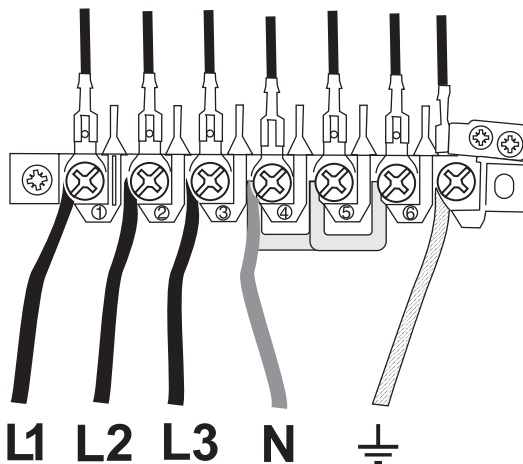

3 phase

Connect the mains cable to the correct terminals for your electrical supply type (see fig.). Check that the links are correctly fitted and that the terminal screws are tight. Secure the mains cable using the cable clamp.

These appliances are of type X with regard to protection against over heating of the surrounding surfaces.

Oven Light

Press the oven light switch and check that the light is working.

NB. The oven light bulb is not included in the guarantee

Hotplate

Check each burner in turn. Push in tap and turn to the large flame symbol. Press ignition switch on fascia panel.

Grill

Open the grill compartment door. Turn on the grill control and check that the grill heats up.

Oven check

The clock must be set to the time of day before the ovens will work.

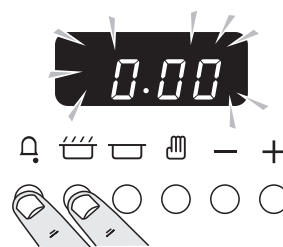

Press and hold as above.

At the same time, press - or + until the correct time shows.

Don't forget it's a 24 hour clock.

If you make a mistake or press the wrong button, turn off the power supply for a minute or two and start again.

Turn on the oven and check that the oven fan starts to turn and that the oven starts to heat up. Turn off the oven.

Fitting the plinth

Loosen the 3 screws along the front bottom edge of the cooker. Hook the central keyhole over the central screw. Twist and fit each end keyhole over their respective screws. Tighten the fixing screws.

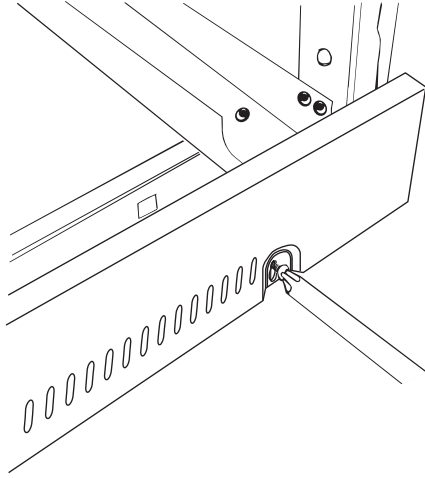

Customer care

Please complete your details in this Guide, inform the user how to operate the cooker and hand over the Instructions.

Thank you.

WARNING - SERVICING TO BE CARRIED OUT ONLY BY AN AUTHORISED PERSON
 Disconnect from electricity and gas before servicing. Check appliance is safe when you have finished.

Conversion to LP gas

Servicing - warning

This conversion must be performed by a competent person. After conversion the installation must comply with the relevant regulations and also the local electricity supply company requirements. Read the instructions before converting this appliance.

Failure to convert the appliance correctly could invalidate any warranty or liability claims and lead to prosecution.

This instruction must be used in conjunction with the rest of the appliance instruction, in particular for information on Standards, cooker positioning, connection hose suitability etc.

When servicing or replacing gas-carrying components disconnect from gas before commencing operation and check appliance is gas sound after completion.

Do not use re-conditioned or unauthorised gas controls.

Conversion

Disconnect from electricity and gas before servicing. Check appliance is safe when you have finished.

This appliance is supplied set for G 20 Natural gas at 20millibar. It packed with a conversion kit for LP gas.

Injectors

Standard burner

Wok burner (some models only)

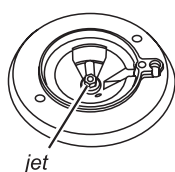

jet

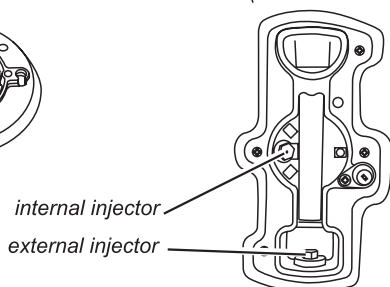

internal injector

external injector

Remove burner caps and heads. Remove old jets. Fit the new jets (see **Technical Data** section at the back of the book for correct jets). Reassemble in reverse order.

Tap adjustment

Disconnect from electricity supply.

Open the oven door & grill door and remove the fixing screws underneath the control panel. The screws directly below the clock are for the clock fixing bracket - don't remove them. Some models have a plate under the control panel held in place by the bottom fixing screws.

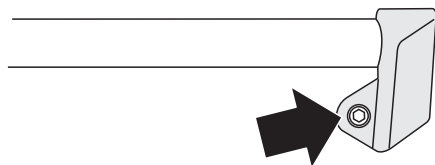

Remove the handrail by removing the 2 end bracket fixing screws.

Remove the 2 cross-headed screws that were hidden by the handrail end brackets.

Pull off all the control knobs.

Lift the control panel, pull forward.

Take care not to damage or strain the wiring.

To convert to other gases.

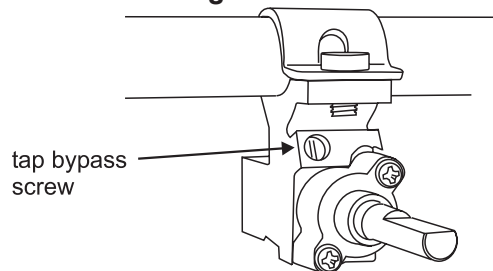

tap bypass screw

Turn the bypass screw on each control clockwise to the stop.

Refit the control panel.

Stick on label

Stick the LP gas label over the natural gas part of the appliance data label.

Pressure Testing

Connect the appliance to the gas supply. Check the appliance is gas sound.

The gas pressure can be measured at one of the left hand hotplate burner jets. Lift off a burner head. Fit the pressure gauge to the jet. Turn on the hotplate burner and turn on and light one of the other burners.

The pressure should be 29mbar for Butane and 37mbar for Propane. After checking the pressure, turn the taps off and replace the burner head.

Reassemble burner top, making sure it is reassembled in the correct way on the burner body.

Check the appliance is gas sound.

Check operation of all the burners.

WARNING - SERVICING TO BE CARRIED OUT ONLY BY AN AUTHORISED PERSON
 Disconnect from electricity and gas before servicing. Check appliance is safe when you have finished.

Servicing Notes

When servicing or replacing gas carrying components disconnect from gas before commencing operation and check appliance is gas sound after completion. When checking for gas leaks use a liquid leak detector at all joints and connections to check for leaks in the system. Use a product specifically manufactured for leak detection. In GB refer to BS 6891.

Leak testing of the appliance shall be conducted in accordance to the manufacturer's instructions.

CAUTION: DO NOT USE A FLAME TO CHECK FOR GAS LEAKS.

Do not use re-conditioned or unauthorised gas controls. Disconnect from electricity supply before commencing servicing, particularly before removing any of the following: control panel, side panels, cooktop tray, or any of the electrical components or cover boxes. Before electrical reconnection check that the appliance is electrically safe.

1 To Remove the Control Panel

Disconnect from electricity supply.

Open the oven door & grill door and remove the fixing screws underneath the control panel. The screws directly below the clock are for the clock fixing bracket - don't remove them at this stage. Some models have a plate under the control panel held in place by the bottom fixing screws.

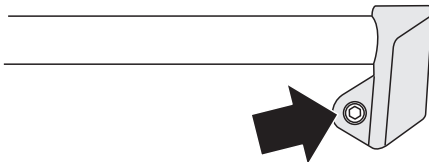

Remove the handrail by removing the 2 end bracket fixing screws.

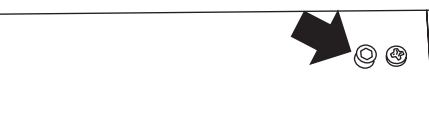

Remove the 2 cross-headed screws that were hidden by the handrail end brackets.

Pull off all the control knobs.

Lift the control panel, pull forward.

Disconnect the wiring from the rear. Reassemble in reverse order. When replacing leads refer to the wiring diagram. Check operation of timer.

2. To Remove Hotplate Trays

Disconnect from electricity supply.

Pull the cooker forward to gain access to the rear

Left hand tray

From the rear remove the screws securing the flue grille to the hotplate tray. Remove pan supports, burner heads and caps. Remove the 4 screws and washers holding the hotplate tray to the frame. Raise the front of the hotplate then withdraw.

Right hand tray

From the rear remove the screws securing the flue grille to the hotplate tray. If the LH hotplate has not been removed, slacken the screws holding the L H tray. Remove pan support, burner head, caps and trim rings. Remove the screws holding the Wok burner to the hotplate. Remove the two screws and washers holding the RH tray to the frame. Press the Wok burner down slightly and, taking care not to damage the Wok burner electrode, slide the tray about 30mm to right to clear the locating brackets on the R H side. Lift tray slightly at the front and taking care not to stress the Warmer/lead junction, disconnect the leads to the Warmer neon and separate the leads at the piggybacks. Withdraw the hotplate.

Reassemble in reverse order ensuring that the leads are reconnected. When replacing the RH hotplate take care not to damage the ignition electrode of the Wok burner.

It is important that the rear fixing screws are refitted as they form part of the cooker earthing.

On some models there is a separate plate.

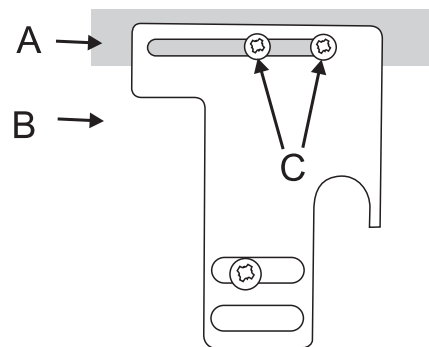

A flue grill, B cooker backsheet, C earthing/fixing screws

On others it is a tag on the cooker backsheet.

It is important that the tag is on the outside and that both fixing screws are fitted.

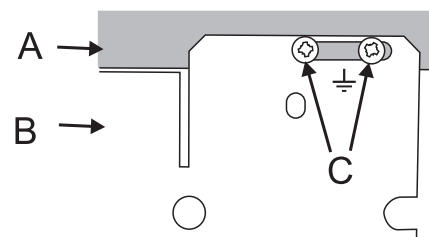

A flue grill, B cooker backsheet, C earthing/fixing screws

Check for correct burner operation.

3. To Remove Side Panels

Disconnect from electricity supply.

Remove the Control Panel - see 1. Pull the cooker forward. Remove the 4 retaining screws for each panel (1 at the front base, 1 on the top and 2 at the rear).

Reassemble in reverse order.

WARNING - SERVICING TO BE CARRIED OUT ONLY BY AN AUTHORISED PERSON
Disconnect from electricity and gas before servicing. Check appliance is safe when you have finished.

4. To Remove Ignition or light Switch

Remove the Control Panel - see 1.

NB. The old switch may be destroyed during removal. Remove the old switch from its bezel by gripping the switch body behind the control panel and twisting sharply. The switch bezel can then be removed by folding back its locking wings and pushing forward. Fit the new bezel to the control panel by first lining up the raised key on its body with the cutout in the control panel and pushing it in from the front. Assemble the new switch to the bezel by lining up the key sections and pushing home. Fit the new button by pushing in from the front.

Replace Control Panel in reverse order and test for ignition.

5. To Remove Clock

Disconnect from electricity supply.

Remove the Control Panel (See 2). Pull off the timer control button(s).

Remove the timer/mounting bracket assembly from the control panel by removing the fixing screws.

Remove the timer from its mounting bracket by depressing the plastic lugs on the timer case, at the same time pulling the unit forward.

Reassemble in reverse order. When replacing leads refer to the wiring diagram. Check operation of timer.

BEFORE SERVICING ANY GAS CARRYING COMPONENTS TURN OFF GAS SUPPLY.

6. To Remove a Thermostat

Remove control panel and appropriate hotplate tray. Open oven door. Remove oven furniture and slide out oven roof liner if fitted. For RH oven, remove thermostat phial cover (2 screws).

Unclip the thermostat phial from the clips in the oven back.

For LH oven pull cooker forward to gain access to the cover box at the rear of the cooker. Remove the four screws securing the cover and lift clear.

Feed the thermostat capillary out of the oven. Disconnect wiring from thermostat. Remove 2 screws holding thermostat to mounting panel. Fit new thermostat and reassemble in reverse order. Ensure that the phial is clipped to the oven back with the phial centrally positioned between the clips.

Check operation of thermostat.

7. To Change Grill Controller

Remove the control panel (see 2) and LH hotplate tray. Disconnect wiring from controller. Remove 2 screws holding controller to mounting panel. Fit new controller and reassemble in reverse order. Check for correct operation.

8. To Change Control Taps

Remove the Control Panel (see 1). Lift up the appropriate hotplate tray front (see 2).

Undo compression fitting at the rear of the tap. Remove the fixings that secure the tap to the gas rail. Remove the tap. Remove and discard the gasket seal. Fit new gasket seal to replacement tap. Re-assemble in reverse order. Check the appliance is gas sound. Check hotplate ignition.

9. To Change Hotplate Burner Injector

Remove burner cap and head. Remove old jet. Fit new injector. Reassemble in reverse order. Check appliance is gas sound.

10. To Change Hotplate Burner Electrode

Lift off pan supports, remove burner cap. Remove the screw holding the electrode. Pull electrode vertically up sufficiently to grip the lead between thumb and forefinger. Pull off the electrode, but keep hold of the lead. Fit new electrode to the lead. Fix electrode in burner with screw. Replace burner cap. Check the burner ignition. Replace pan supports.

11. To Remove or Change a Hotplate Burner.

Remove the hotplate tray (see 2).

LH hotplate burners

Remove heat shield (2 screws). The burners are mounted in 2's on cross supports. Disconnect the burner feed pipes at the burners. Remove the screw on the right holding the cross support. Slide the support to the right to release in from the left hand location. Lift the cross support and burners clear. The burners are fixed to the cross supports with 2 screws. Remove the appropriate burner and fit the new one. Reassemble in reverse order. Check burner operation is satisfactory.

RH Wok burner

Disconnect the burner feed pipes at the burner. Fit the new one and reassemble in reverse order. Check burner operation is satisfactory.

12. To Remove an Oven Door

Open oven door. Support the door and remove the two screws securing the upper hinge and gasket to the cooker front. Remove the door from the lower hinge by lifting slightly and moving outwards.

Reassemble in reverse order.

13. To Change Ignition Generator

Disconnect from electricity supply.

Pull cooker forward to gain access to the cover box at the rear of the cooker. Remove the screws securing the cover and lift clear. Pull off all the leads to the generator noting their positions. Slacken the two screws holding generator to cooker and remove generator.

Fit new generator to cooker and replace leads. Reassemble in reverse order. Refer to wiring diagram. Check ignition performance.

WARNING - SERVICING TO BE CARRIED OUT ONLY BY AN AUTHORISED PERSON
 Disconnect from electricity and gas before servicing. Check appliance is safe when you have finished.

14. To Change Oven Door Outer Panel

Move the cooker forward to gain access to the sides.

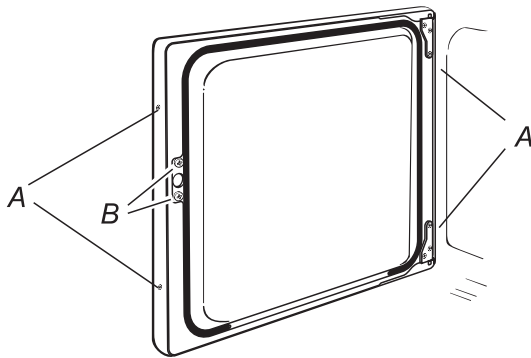

Open the oven door slightly and remove the front panel fixing screws from both sides of the outer panel (A).

Carefully lift off the outer panel.

Remove the door handle from the panel by unscrewing the 2 retaining nuts.

Fit the door handle to the new panel. Fit the new panel to the door. Then reassemble in reverse order.

15. To Change Oven Door Latch

Remove outer door panel (see 14). Remove screws 'B' holding latch assembly to inner door panel. Fit new catch and reassemble in reverse order.

Check correct door operation.

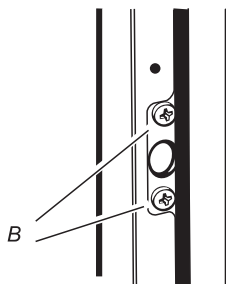

16. To Adjust an Oven Door Catch Keep

Open oven door, slacken off locknut at base of keep, and screw in or out as required until required fit is obtained. Retighten locking nut.

17. To Change Oven Door Seal

Open oven door. The seal is held in place by small hooks on the rear face. At the corner pull seal diagonally away from the door centre until that hook is released. Proceed to the next hook and release it in a similar way, and so on. Use force if the hooks are stiff, as the old seal will be discarded.

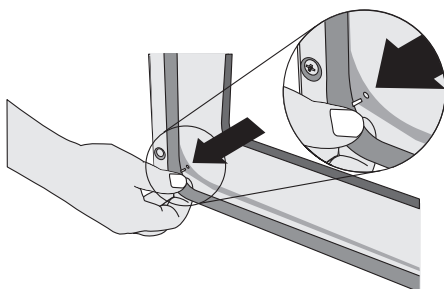

When fitting new seal, position the seal join at the bottom. Hook the new seal in one of the corner holes of the door, and proceed round the door snapping in each hook in turn.

18. To Adjust Oven Door Catch Keep

Open oven door, slacken off locknut at base of keep, and screw in or out as required until required fit is obtained. Retighten locking nut.

19. To Remove Grill Element.

Disconnect from electricity supply.

Remove grill pan from grill chamber. From inside grill compartment remove enamelled front shield from grill roof, 2 screws and washers. Remove 2 screws and washers securing the grill element front support. Remove the screws from the grill elements.

Lift elements out carefully, disconnect the leads from the element terminals noting their position. If it is not possible to disconnect the leads in this way, pull cooker forward to gain access to the rear, remove screws securing the electric cover to the back sheet and remove cover and disconnect the terminals from the rear.

Fit new elements, reassemble in reverse order. Check operation of grill.

20. To Remove RH Oven Inner Back.

Open RH oven door and remove the screws and washers securing the inner back to the back of the oven.

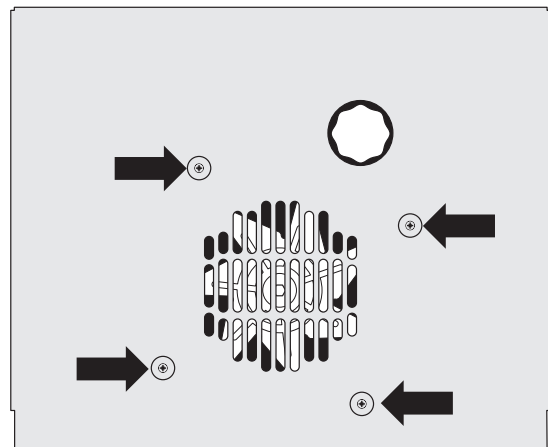

Carefully lift away the inner back. Reassemble in reverse order making sure that the 4 screws and washers are fully tightened.

21. To Change Fan in RH Oven.

Disconnect from electricity supply.

Pull cooker forward to gain access to the rear. Remove screws securing the electric cover to the back sheet and remove cover. Disconnect the 3 terminals connected to the fan noting their position. Remove oven inner back (see 20). Hold the fan blade and remove the centre nut (left hand thread) 2 brass washers, fan blade and Circlip. Unscrew fan retaining nuts and washers (3 off each) and lift the fan away from the rear of the cooker. Fit new fan and reassemble in reverse order. Check operation of oven.

WARNING - SERVICING TO BE CARRIED OUT ONLY BY AN AUTHORISED PERSON
Disconnect from electricity and gas before servicing. Check appliance is safe when you have finished.

22. To Remove RH Oven Element.

Disconnect from electricity supply.

Remove oven inner back (see 19).

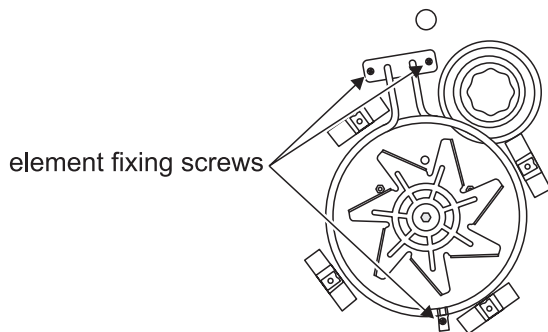

Remove 2 screws from the top of the element and 1 from the bottom of the element in side the oven. Lift element out carefully, disconnect the terminals connected to the element noting their positions. If it is not possible to disconnect the leads in this way, pull cooker forward to gain access to the rear, remove screws securing the electric cover to the back sheet and remove cover and disconnect the terminals from the rear.

Fit new element, and reassemble in reverse order. Check operation of oven.

23. To Remove LH Oven Elements.

Disconnect from electricity supply.

Pull cooker forward to gain access to the rear. Remove screws securing the electric cover to the back sheet and remove cover. Remove the 4 terminals connected to the top element noting their position. Remove 2 screws and washers securing the bottom element cover. Remove the 2 terminals connected to the bottom element noting their position. Remove 2 screws and washer from the bottom element support. Remove 2 screws and washer from the element bracket and withdraw the element. Fit new element, reassemble in reverse order. Open LH oven door and remove 2 screws and washers securing the top element heat shield. Remove 2 screws and washers from the top element bracket and withdraw. Fit new element, reassemble in reverse order. Check operation of oven.

24. To change oven light bulb.

LH Oven

Remove the oven furniture and side linings. Remove the oven rear liner.

RH Oven

Remove the oven inner back (see 19). The oven light cover is now accessible. Unscrew the cover.

Unscrew the bulb.

Fit an Edison screw fitting 15w 240v lamp, FOR OVENS. It must be a special bulb, heat resistant to 300°C.

Circuit Diagram

L

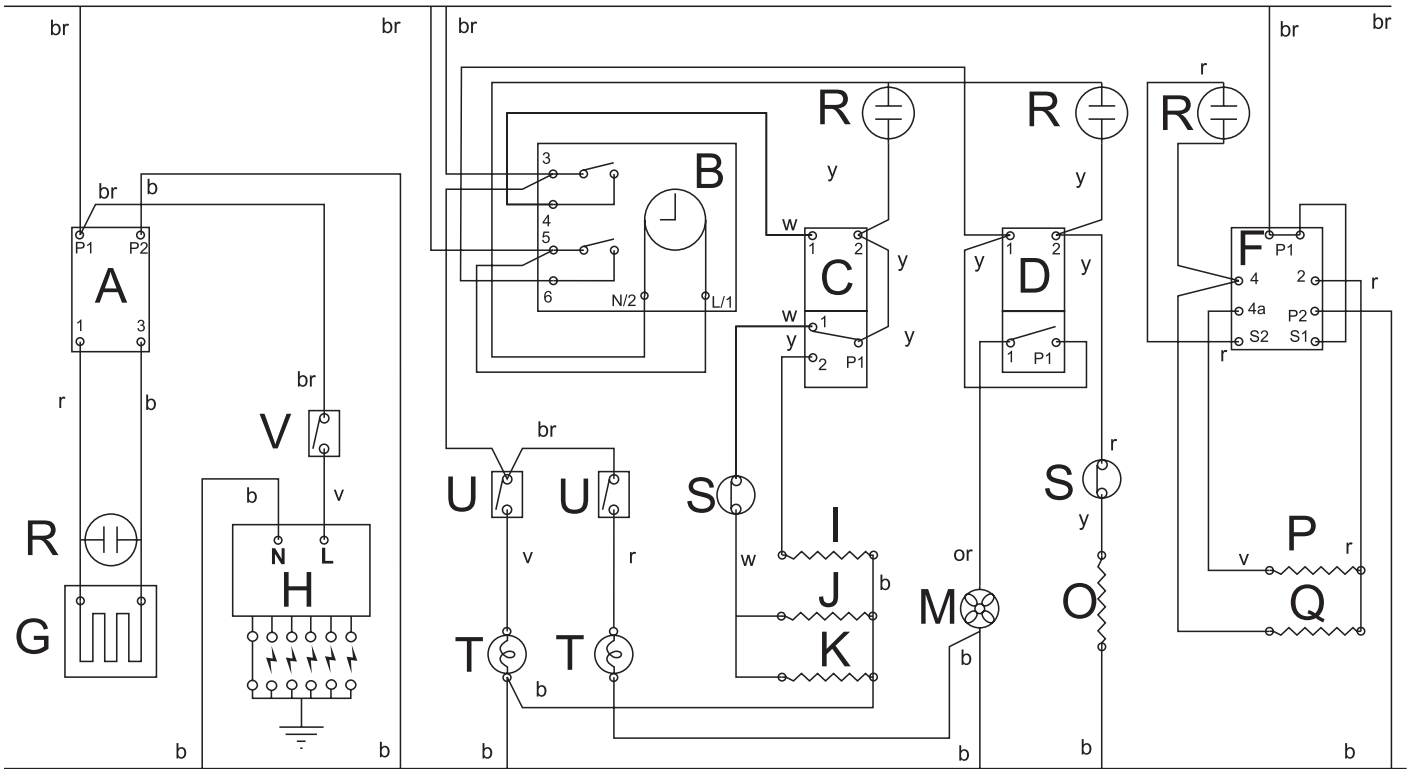

N

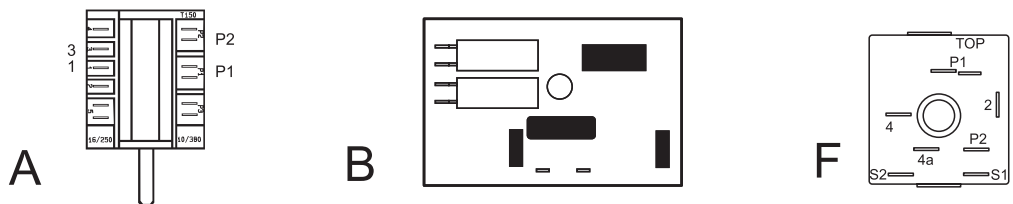

Connection shown in circuit diagram is for single phase. Ratings are for 230V 50Hz

Key to circuit diagram

A Warmer Switch
 B Clock
 C Left hand oven thermostat
 D Right hand oven thermostat
 F Grill energy regulator
 G Warmer 147W
 H Spark generator
 I Base element 1.0kW
 J Top element 1.2kW
 K Browning element 1.15kW
 L Live
 M Right hand oven fan
 N Neutral
 O Fan oven element 2.5kW

P Right hand grill element 1.15kW
 Q Left hand grill element 1.15kW
 R Neon
 S Cutouts
 T Oven light bulbs
 U Oven light switches
 V Ignition switch

Colour Code
 b - Blue
 br - Brown
 or - Orange
 r - Red
 v - Violet
 w - White
 y - Yellow

Technical Data

This cooker is category II2H3+

It is supplied set for group H natural gas. A conversion kit from NG to LP gas is packed with the cooker.

INSTALLER: Please leave these instructions with the User.

DATA BADGE LOCATION : LOWER RIGHT HAND COOKER UPRIGHT (Remove storage drawer)

Country of Destination: GB

Gas		Electric
Natural Gas	20mbar	220 - 240V 50Hz
Butane	29mbar	
Propane	37mbar	

(See appliance data badge for test pressures)

Dimensions

Overall height including optional splashback	minimum 1060mm	maximum 1090mm
Overall height	minimum 893mm	maximum 920mm
Overall width	1100mm See 'Positioning of Cooker'	
Overall depth	648mm	
Space for fixing	See 'Positioning of Cooker'	
Minimum space above hotplate	650mm	

Connections

Gas:	Electric
Rp 1/2 at rear right-hand side	220 - 240V 50Hz

Ratings

Hotplate	Natural Gas		L.P. Gas	
		Injector		Injector
Wok burner	3.5kW	internal 80	3.5kW (246g/h)	internal 54
		external 129		external 77
Large Burner	3.0kW	134	3.0kW (210g/h)	87
Medium Burners	1.7kW	109	1.7kW (119g/h)	68
Small Burner	1.0kW	75	1.0kW (70g/h)	51

Gas burner inputs based on Gross Calorific Value

Ovens	Conventional		Forced air convection
	Oven	Browning Element	
	2.2 kW	1.15kW	2,5 kW
Energy efficiency class : on a scale of A (more efficient) to G (less efficient)	A		A
Energy consumption based on standard load	0.99kWh		0.85kWh
Usable volume (litres)	67		67
Size	Large		Large
Time to cook standard load	40 minutes		38 minutes
Surface area of the grid	1400cm ²		1400cm ²

Grill	2.3kW
Warmer	160W

Maximum total electrical load at 230V 7.2kW (approximate total including oven lights, oven fan etc.)

RANGEmaster

Clarence Street, Royal Leamington Spa,
Warwickshire, CV31 2AD, England.
Tel: +44 (0) 1926 457400 Fax: +44 (0) 1926 450526
E-mail: consumers@rangemaster.co.uk
www.rangemaster.co.uk

AGA FOODSERVICE GROUP

